

ΚΛΙΜΑΤΙΣΤΙΚΑ ΣΥΣΤΗΜΑΤΑ
AIR CONDITIONING SYSTEMS

Ασύρματο Τηλεχειριστήριο YB1FA Εγχειρίδιο Χρήστη

Wireless Remote Controller YB1FA Owner's Manual

Σας ευχαριστούμε που επιλέξατε τη μονάδα κλιματισμού της INVENTOR. Για τη σωστή χρήση της μονάδος, παρακαλούμε διαβάστε προσεκτικά το παρόν εγχειρίδιο και φυλάξτε το για αναφορά στο μέλλον.

Thank you for choosing INVENTOR air conditioning system. For correct use of this unit, please read this manual carefully and keep it for future reference.

English/Ελληνικά/ Româna

 **inventor**
Your-conditions

Contents

1 User notice	1
2 Control panel of the wireless remote controller	1
3 Introduction for special function.....	4
4 Replacement of Batteries	5

1 User notice





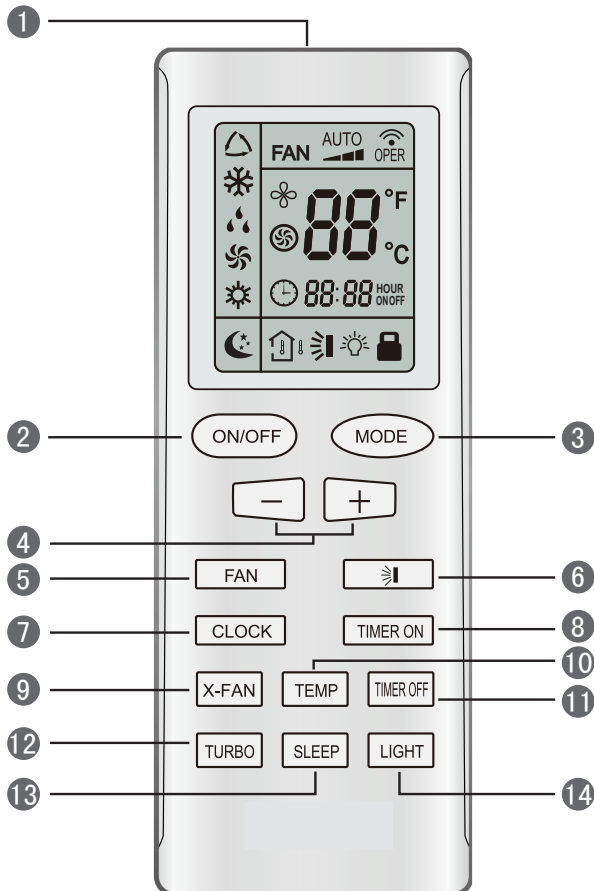

 CAUTION !	
①	Make sure there is no obstruction between the wireless remote controller and the signal receiver.
②	The signal receiving distance of the wireless remote controller can be up to 10 metres.
③	Never drop or throw the wireless remote controller.
④	Never let any liquid flow into the wireless remote controller.
⑤	Never expose the wireless remote controller under the sunlight directly or where it is very hot.
⑥	This is a general remote control, it could be used for multiple types (functions) of air conditioners. For some models without the functions specified here, we preserve the right to not to inform exclusively.

2 Control panel of the wireless remote controller



No.	Name	Function Description
1	Signal transmitter	<ul style="list-style-type: none"> Signal transmitter
2	ON/OFF button	<ul style="list-style-type: none"> Press this button, and the unit will be turned on; press it once more, and the unit will be turned off. When turning off the unit, the Sleep function will be canceled, but the presetting time is still remained.
3	MODE button	<ul style="list-style-type: none"> By pressing this button, Auto, Cool, Dry, Fan, Heat mode can be selected circularly. Auto mode is default after power on. Under the Auto mode, the setting temperature will not be displayed; Under the Heat mode, the initial value is 28°C (82°F); Under other modes, the initial value is 25°C(77°F). <p>△ AUTO ; ❄️ COOL; 💧 DRY; 🌀 FAN; ☀️ HEAT (only for cooling and heating unit)</p>
4	- button	<ul style="list-style-type: none"> Preset temperature can be decreased by pressing this button. Pressing and holding this button for more than 2 seconds can make the temperature changed quickly until release this button and then transmit this order. The temperature adjustment is unavailable under the Auto mode, but the order can be sent by pressing this button. Centigrade setting range: 16-30; Fahrenheit scale setting range 61-86.
	+ button	<ul style="list-style-type: none"> Preset temperature can be increased by pressing this button. Pressing and holding this button for more than 2 seconds can make the temperature changed quickly until release the button and then transmit this order. The temperature adjustment is unavailable under the Auto mode, but the order can be sent by pressing this button. Centigrade setting range: 16-30; Fahrenheit scale setting range 61-86.
5	FAN button	<ul style="list-style-type: none"> By pressing this button, Auto, Low, Middle, High speed can be circularly selected. After power on, Auto fan speed is default. <p> — AUTO — — — — — ▬ Low speed ▬▬ Middle speed ▬▬▬ High speed </p> <p>Note: Under the DRY mode, the fan will be kept running at the low speed and the fan speed isn't adjustable.</p>

<p>6</p>	<p>SWING UP/DOWN button</p>	<ul style="list-style-type: none"> Press this button to set up the swing angle, which circularly changes as below: When the guide louver starts to swing up and down, if SWING functions is canceled, the air guide louver will stop and remains at the current position. ☞ indicates the guide louver swings up and down among those five directions. (Simplified SWING function applicable for some Fan Coil Units: When the wireless remote controller is energized initially with the unit under the OFF status, it should be set by pressing the + button and the SWING button simultaneously, with the symbol ☞ blinking twice. Then, after the unit is turned on, this function can be activated by pressing the SWING button, with the displayed symbol ☞ indicating swing function is on and without this displayed symbol indicating swing function is off.)
<p>7</p>	<p>CLOCK button</p>	<ul style="list-style-type: none"> By pressing this button, the clock is allowed to be set, with ⌚ blinking, and then press the +/- button to adjust the clock within 5 seconds. If the +/- button is pressed down constantly for more than 2 seconds, the clock setting will be increased or decreased 10 minutes every 0.5 seconds. After that, another press on the CLOCK button accepts the setting. 12:00 is the default, when the wireless remote controller is energized.
<p>8</p>	<p>TIMER ON button</p>	<ul style="list-style-type: none"> When TIMER ON is activated, ON will blink while the symbol ⌚ will disappear. Within 5 seconds it is allowed to set the ON time by pressing the +/- button. Each press will make the time increase or decrease one minute. Besides, the time can also be set by pressing the +/- button constantly. that is, in the early 2.5 seconds, the time will increase/decrease quickly per single minute, and in the late 2.5, the time will increase/decrease per ten minutes. After the desired time value is set, press TIENE ON again to conform the setting within five seconds. After that, another press on TIMER ON will cancel the setting. Prior to this setting, the clock shall be set to the actual time.
<p>9</p>	<p>X-FAN button</p>	<ul style="list-style-type: none"> Pressing this button can activate or deactivate the X-FAN function. In Cool or Dry mode, by pressing this button, if "☞" is displayed, it indicates the X-FAN function is activated. By repressing this button, if "☞" disappears, it indicates the X-FAN function is deactivated. After energization, X-FAN OFF is defaulted. If the unit is turned off, X-FAN can be deactivated but can't be activated.

<p>10</p>	<p>TEMP button</p>	<ul style="list-style-type: none"> By pressing this button it is allowed to select displaying the indoor setting temperature or the indoor ambient temperature. Indoor setting temperature is default after the indoor unit is energized initially. By pressing the TEMP button, when the temperature symbol  is displayed, the indoor displayer will show the indoor setting temperature; when  is displayed, it will show the indoor ambient temperature; when  is invalidation, If current displays indoor ambient temperature, if received the other remote control signal, it will display presetting temperature, 5s later, will back to display the ambient temperature. (This function is applicable to partial of models)
<p>11</p>	<p>TIMER OFF button</p>	<ul style="list-style-type: none"> By pressing this button it is available to go to the TIMER OFF setting state with the same setting method as that of the TIMER ON, in which case the OFF symbol blinks.
<p>12</p>	<p>TURBO button</p>	<ul style="list-style-type: none"> In the Cool or Heat mode, pressing this button can activate or deactivate the TURBO function. When the TURBO function is activated, its symbol  will be displayed; when the running mode or the fan speed is changed, this function will be canceled automatically. (This function is applicable to partial of models).
<p>13</p>	<p>SLEEP button</p>	<ul style="list-style-type: none"> By pressing this button, Sleep On and Sleep Off can be selected. After powered on, Sleep Off is defaulted. Once the unit is turned off, the Sleep function is canceled. When Sleep is set to On, the symbol of SLEEP  will display. Under the Fan and Auto modes, this function is not available.
<p>14</p>	<p>LIGHT button</p>	<ul style="list-style-type: none"> Press this button to select LIGHT on or off in the displayer. When the LIGHT is set to on, the icon  will be displayed and the indicating light in the displayer will be on. When the LIGHT is set to off, the icon  will be disappeared and the indicating light in the displayer will be off.

3 Introduction for special function

- **About X-FAN function** (This function is applicable to some special models)

This function indicates that moisture on evaporator of indoor unit will be blown after the unit is stopped to avoid mould.

This function indicates that moisture in the evaporator of the indoor unit will be blew out after the unit is stopped so as to avoid mould.

① With X-FAN function ON: After turning off the unit by pressing ON/OFF button indoor fan will continue running for several minutes at low speed. In this period, press X-FAN button to stop indoor fan directly.

② With X-FAN function OFF: After turning off the unit by pressing ON/OFF button, the complete unit will be off directly.

- **About TURBO function** (This function is applicable to some special models)

If the TURBO function is activated, the unit will run at high fan speed to perform cooling or

heating quickly so that the ambient temperature will approach the preset temperature as soon as possible.

- **About lock**

Press + and - buttons simultaneously to lock or unlock the keyboard. If the wireless remote controller is locked, the icon  will be displayed on it, in which case, any press will get no response but with the mark blinking for three times. If the keyboard is unlocked, the mark will disappear.

- **About SWING UP/DOWN**

① Press the Swing Up/Down button for more than 2 seconds and then the louvre will swing up and down. After releasing the button, the louvre will stop swinging and keep the current status.

② When the louvre starts swinging, by pressing the Swing Up/Down button 2 seconds later, the louvre will stop swinging directly; while, by pressing the Swing Up/Down button within 2 seconds, the louver will keep swinging.

- **About Change over switch between Fahrenheit and Centigrade**

Under the OFF state of the unit, press MODE and - buttons simultaneously to switch between °C and °F.

4 Replacement of batteries

① Slightly press the place with  along the arrowhead direction and push the back cover of the wireless remote controller.

② Take out the used batteries.

③ Insert two new AAA 1.5V dry cell batteries and pay attention to their polarity.

④ Put back the cover of the wireless remote controller.

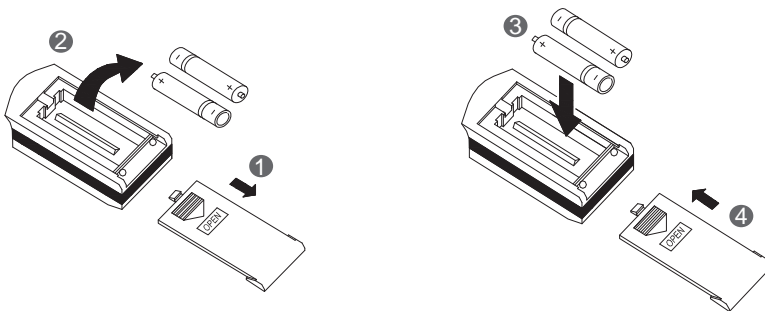

Notes!

① When changing the batteries, do not use the used or different-type batteries, otherwise, it would cause some malfunction to the wireless remote controller.

② If the wireless remote controller will not be used for a long time, please take them out, and don't let the battery liquid damage the wireless remote controller.

③ The operation should be within the signal receiving range.

④ It should be placed 1m away from the TV set or stereo sound sets.

⑤ If the wireless remote controller can not operate normally, please take batteries out for 30s. If the anomaly persists, please change them.

⑥ The battery must be removed from the appliance before it is scrapped. The batteries is to be disposed of safely.

Περιεχόμενα









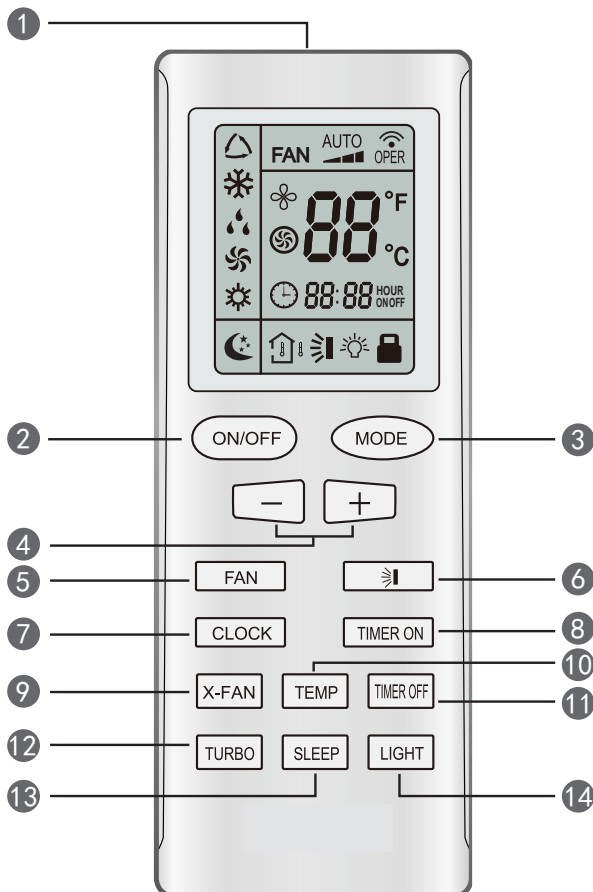

1 Σημειώσεις για τη χρήση	7
2 Περιγραφή πλήκτρων του ασύρματου τηλεχειριστηρίου	7
3 Ειδικές λειτουργίες	10
4 Αντικατάσταση μπαταριών	11





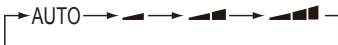



1 Σημειώσεις για τον χρήση

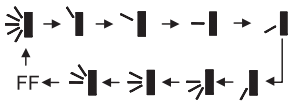





 ΠΡΟΣΟΧΗ!	
①	Βεβαιωθείτε πως δεν υπάρχει κάποιο εμπόδιο ανάμεσα στο ασύρματο τηλεχειριστήριο και τον δέκτη σήματος
②	Το ευρος λειτουργίας του ασύρματος τηλεχειριστηρίου είναι μέχρι 10m
③	Μην ρίχνετε ή πετάτε το ασύρματο τηλεχειριστήριο
④	Μην επιτρέψετε την εισροή υγρού μέσα στο τηλεχειριστήριο
⑤	Μην έχετε εκτεθειμένο το ασύρματο τηλεχειριστήριο στον ήλιο ή σε πολύ ζεστό μέρος
⑥	Αυτό το τηλεχειριστήριο είναι γενικής χρήσεως και χρησιμοποιείται για διάφορα μοντέλα. Για κάποια μοντέλα χωρίς κάποιες από τις αναφερόμενες λειτουργίες, δεν θα γίνεται εκτενής περιγραφή.

2 Περιγραφή ασύρματος λειτουργιών τηλεχειριστηρίου



No.	Ονοματολογία	Περιγραφή Λειτουργίας
1	Μεταδότης Σήματος	<ul style="list-style-type: none"> Μεταδότης σήματος
2	Πλήκτρο ON/OFF	<ul style="list-style-type: none"> Πιέστε αυτό το πλήκτρο για να ενεργοποιήσετε τη μονάδα. Πιέστε το άλλη μια φορά για να την απενεργοποιήσετε. κατά την απενεργοποίηση της μονάδας η λειτουργία sleep θα ακυρωθεί αλλά θα παραμείνει η αρχικά ρυθμισμένη ώρα.
3	Πλήκτρο MODE	<ul style="list-style-type: none"> Κάθε φορά που πιέζετε αυτό το πλήκτρο, επιλέγεται η κατάσταση λειτουργίας με την παρακάτω σειρά: auto (αυτόματο), cool (ψύξη), dry(αφύγρανση), fan(ανεμιστήρας) και heat (θέρμανση). Κατά την ενεργοποίηση της μονάδας, είναι προεπιλεγμένη η κατάσταση auto. Στην κατάσταση AUTO δεν εμφανίζεται στην οθόνη επιλεγμένη θερμοκρασία και η μονάδα θα επιλέξει αυτόματα την κατάλληλη κατάσταση λειτουργίας ανάλογα με τη θερμοκρασία που έχει ο χώρος, κατά τη λειτουργία της θέρμανσης η αρχική επιλογή είναι 28°C (82°F) και για τις υπόλοιπες είναι 25°C (77°F).  <p>  AUTO ;  COOL;  DRY;  FAN;  HEAT (μόνο για μονάδες τύπου αντλίας θερμότητας) </p>
4	Πλήκτρο -	<ul style="list-style-type: none"> Πιέστε αυτό το πλήκτρο για να μειώσετε την επιλεγμένη θερμοκρασία. Πιέζοντάς το για 2 δευτερόλεπτα συνεχόμενα, τότε η θερμοκρασία επιλογής θα μειωθεί γρήγορα. Στην κατάσταση AUTO δεν υπάρχει διαθέσιμη αυτή η επιλογή αλλά η εντολή μπορεί να δοθεί πιέζοντας αυτό το πλήκτρο Εύρος επιλογής θερμοκρασίας σε κελσίου: 16-30 και σε φarenάιτ: 61-86
	Πλήκτρο +	<ul style="list-style-type: none"> Πιέστε αυτό το πλήκτρο για να αυξήσετε την επιλεγμένη θερμοκρασία. Πιέζοντάς το για 2 δευτερόλεπτα συνεχόμενα, τότε η θερμοκρασία επιλογής θα αυξηθεί γρήγορα. Στην κατάσταση AUTO δεν υπάρχει διαθέσιμη αυτή η επιλογή αλλά η εντολή μπορεί να δοθεί πιέζοντας αυτό το πλήκτρο. Εύρος επιλογής θερμοκρασίας σε κελσίου: 16-30 και σε φarenάιτ: 61-86
5	Πλήκτρο FAN	<ul style="list-style-type: none"> Με αυτό το πλήκτρο μπορείτε να ρυθμίσετε την ταχύτητα του ανεμιστήρα η οποία αλλάζει από AUTO,σε low (χαμηλή), middle(μεσαία), high(υψηλή) και μετά πάλι σε auto.  <ul style="list-style-type: none">  χαμηλή ταχύτητα  μεσαία ταχύτητα  υψηλή ταχύτητα <p>Σημείωση: κατά τη λειτουργία dry ο ανεμιστήρας θα λειτουργεί στη χαμηλή ταχύτητα και δεν υπάρχει η δυνατότητα αλλαγής</p>

<p>6</p>	<p>Πλήκτρο SWING UP/DOWN</p>	<ul style="list-style-type: none"> • Πιέστε το συγκεκριμένο πλήκτρο για να ρυθμίσετε τη γωνία κίνησης πάνω και κάτω, η οποία αλλάζει όπως εμφανίζεται παρακάτω:  <ul style="list-style-type: none"> • Εάν ακυρωθεί η λειτουργία όταν η περσίδα έχει ξεκινήσει να κινείται πάνω και κάτω, τότε θα σταματήσει στη θέση που βρίσκεται εκείνη τη στιγμή. • Το σύμβολο  υποδεικνύει ότι η περσίδα κινείται σε αυτές τις 5 κατευθύνσεις. (όταν η μονάδα ενεργοποιηθεί για πρώτη φορά αλλά βρίσκεται σε κατάσταση off, η συγκεκριμένη λειτουργία μπορεί να επιλεγεί πιέζοντας ταυτόχρονα τα πλήκτρα + και swing και τότε το σύμβολο  θα αναβοσβήνει 2 φορές. όταν η μονάδα έχει ενεργοποιηθεί και λειτουργεί, η επιλογή αυτής της λειτουργίας γίνεται πιέζοντας το πλήκτρο swing και στην οθόνη εμφανίζεται το σύμβολο  εάν το σύμβολο αυτό δεν εμφανίζεται στην οθόνη, τότε η λειτουργία swing είναι ανενεργή.)
<p>7</p>	<p>Πλήκτρο CLOCK</p>	<ul style="list-style-type: none"> • Πιέζοντας αυτό το πλήκτρο, αναβοσβήνει η ένδειξη  εντός 5 δευτερολέπτων, πιέζοντας το πλήκτρο + ή - μπορείτε να ρυθμίσετε την ώρα. Κρατώντας πατημένα ένα από τα 2 πλήκτρα πάνω από 2 δευτερόλεπτα η ώρα αλλάζει κατά 10 λεπτά ανά 0,5 δευτερόλεπτα. Αφού ολοκληρώσετε τη ρύθμιση πιέστε άλλη μια φορά το πλήκτρο clock για την επιβεβαίωση και η ένδειξη θα είναι σταθερά αναμμένη. Η εργοστασική ρύθμιση είναι 12:00.
<p>8</p>	<p>Πλήκτρο TIMER ON</p>	<ul style="list-style-type: none"> • Πίεστε το συγκεκριμένο πλήκτρο για να ενεργοποιήσετε τον χρονοδιακόπτη αυτόματης ενεργοποίησης. Για να ακυρώσετε τη συγκεκριμένη λειτουργία απλά πιέστε άλλη μια φορά το ίδιο πλήκτρο. Πιέζοντας αυτό το πλήκτρο εξαφανίζεται το σύμβολο  και αναβοσβήνει το ON. Εμφανίζεται η ένδειξη 00:00 για να επιλέξετε τη ρύθμιση. Εντός 5 δευτερολέπτων πιέστε το πλήκτρο + ή - για να ρυθμίσετε την ώρα. Κάθε φορά που πιέζεται κάποιο από τα 2 πλήκτρα η ρύθμιση αλλάζει κατά 1 λεπτό. Κρατώντας πατημένο όποιο από τα 2 πλήκτρα η ρύθμιση θα αλλάξει γρήγορα κατά 1 λεπτό και μετά κατά 10λεπτά. Εντός 5 δευτερολέπτων πιέστε το πλήκτρο timer on για την επιβεβαίωση.
<p>9</p>	<p>Πλήκτρο X-FAN</p>	<ul style="list-style-type: none"> • Σε κατάσταση cool ή dry, εάν πιέσετε το πλήκτρο x-fan εμφανίζεται στην οθόνη η ένδειξη  και η συγκεκριμένη λειτουργία έχει επιλεγεί. πιέζοντας άλλη μια φορά το ίδιο πλήκτρο, τότε απενεργοποιείται η συγκεκριμένη λειτουργία και το σύμβολο  εξαφανίζεται. Το x-fan είναι προεπιλεγμένο σε κατάσταση off. Εάν απενεργοποιήσετε τη μονάδα ακυρώνεται η επιλογή.

10	Πλήκτρο TEMP	<ul style="list-style-type: none"> • Με αυτό το πλήκτρο μπορείτε να επιλέξετε την ένδειξη είτε την επιλεγμένη θερμοκρασία είτε τη θερμοκρασία του χώρου. • Όταν η μονάδα ενεργοποιηθεί για πρώτη φορά θα εμφανίζεται στην οθόνη η επιλεγμένη θερμοκρασία. • Πιέζοντας το πλήκτρο TEMP, όταν εμφανιστεί το σύμβολο  τότε εμφανίζεται η επιλεγμένη θερμοκρασία. Όταν εμφανίζεται το σύμβολο  τότε εμφανίζεται η θερμοκρασία του χώρου. Το σύμβολο  σημαίνει ακύρωση. Εάν εμφανίζεται η θερμοκρασία του χώρου και δοθεί οποιαδήποτε εντολή, τότε θα εμφανιστεί η επιλεγμένη θερμοκρασία και 5 δευτερόλεπτα εργότερα θα εμφανίσει πάλι τη θερμοκρασία περιβάλλοντος. (αυτή η λειτουργία ισχύει σε κάποια μοντέλα)
11	Πλήκτρο TIMER OFF	<ul style="list-style-type: none"> • Πιέστε αυτό πλήκτρο για να ρυθμίσετε τον χρονοδιακότη αυτόματης απενεργοποίησης της μονάδας. Για να ακυρώσετε τη συγκεκριμένη ρύθμιση, απλά πιέστε άλλη μια φορά το ίδιο πλήκτρο. Η ρύθμιση του TIMER OFF γίνεται όπως και για το TIMER ON.
12	Πλήκτρο TURBO	<ul style="list-style-type: none"> • Πιέστε αυτό το πλήκτρο  για να ενεργοποιήσετε/απενεργοποιήσετε τη λειτουργία turbo, δίνοντας την δυνατότητα στη μονάδα να επιτύχει την επιθυμητή θερμοκρασία σε σύντομο χρονικό διάστημα. Σε κατάσταση ψύξης, η μονάδα θα φυσάει κρύο αέρα σε πολλή υψηλή ταχύτητα. Σε κατάσταση θέρμανσης, η μονάδα θα φυσάει θερμό αέρα σε πολλή υψηλή ταχύτητα. (η συγκεκριμένη επιλογή δεν έχει εφαρμογή σε κάποια μοντέλα)
13	Πλήκτρο SLEEP	<ul style="list-style-type: none"> • Πιέστε αυτό το πλήκτρο για να επιλέξετε την κατάσταση sleep και πιέστε το άλλη μια φορά για να την ακυρώσετε. Αυτή η λειτουργία είναι διαθέσιμη σε κατάσταση ψύξης(cool), θέρμανσης (heat) (μόνο για μονάδες τύπου αντλίας θερμότητας) ή σε κατάσταση dry (αφύγραση) έτσι ώστε να διατηρείται η βέλτιστη θερμοκρασία. Όταν έχει επιλεγεί η συγκεκριμένη επιλογή τότε εμφανίζεται το σύμβολο .
14	Πλήκτρο LIGHT	<ul style="list-style-type: none"> • Πιέζοντας το πλήκτρο light ενεργοποιείται ο φωτισμός της οθόνης και εμφανίζεται η ένδειξη . Αν το πιέσετε άλλη μια φορά απενεργοποιείται ο φωτισμός και η ένδειξη εξαφανίζεται.

3 Ειδικές λειτουργίες

- **Σχετικά με το x-fan** (η εντολή αυτή έχει εφαρμογή σε κάποια μοντέλα)

Αυτή η λειτουργία υπάρχει έτσι ώστε να απομακρυνθεί η υγρασία από την εσωτερική μονάδα παρόλο που η μονάδα έχει απενεργοποιηθεί.

1. Ενεργή η λειτουργία x-fan: Όταν απενεργοποιήσετε τη μονάδα, πιέσετε το πλήκτρο on/off και ο εσωτερικός ανεμιστήρας θα λειτουργεί για κάποια λεπτά στη χαμηλή ταχύτητα. Πιέζοντας το πλήκτρο x-fan ο ανεμιστήρας θα σταματήσει αμέσως.
2. Λειτουργία x-fan ανενεργή: Όταν απενεργοποιήσετε τη μονάδα με το πλήκτρο On/off, τότε θα απενεργοποιηθεί.

- **Σχετικά με τη λειτουργία turbo**(αυτή η λειτουργία έχει εφαρμογή σε κάποια μοντέλα)
Σε κατάσταση ψύξης, η μονάδα θα φυσάει κρύο αέρα σε πολλή υψηλή ταχύτητα. Σε κατάσταση θέρμανσης, η μονάδα θα φυσάει θερμό αέρα σε πολλή υψηλή ταχύτητα.

• **Σχετικά με το κλείδωμα (lock)**

Πιέστε ταυτόχρονα τα πλήκτρα + και - για να κλειδώσετε ή ξεκλειδώσετε το πληκτρολόγιο. Εάν το ασύρματο τηλεχειριστήριο είναι κλειδωμένο, θα εμφανιστεί το σύμβολο  και αν πιέσετε οποιοδήποτε πλήκτρο θα αναβοσβήσει 3 φορές και καμιά εντολή δεν θα δοθεί. Όταν το ξεκλειδώσετε τότε το σύμβολο θα εξαφανιστεί.

• **Σχετικά με το swing up/down**

1. Πιέστε το πλήκτρο swing up/down για περισσότερο από 2 δευτερόλεπτα και η περσίδα θα αρχίσει να κινείται πάνω και κάτω. Όταν αφήσετε το πλήκτρο τότε η περσίδα θα σταματήσει στη θέση που θα βρίσκεται εκείνη τη στιγμή.

2. Εάν πιέσετε το πλήκτρο swing up/down 2 δευτερόλεπτα αφού η περσίδα έχει ξεκινήσει να κινείται, τότε θα σταματήσει αμέσως. Ενώ αν το πιέσετε εντός 2 δευτερολέπτων, η περσίδα θα συνεχίσει να κινείται.

• **Αλλαγή από φαρεναίτ σε κελσίου και αντίστροφα.**

Όταν η μονάδα είναι απενεργοποιημένη, πιέστε ταυτόχρονα τα πλήκτρα MODE και - για να αλλάξετε από °F σε °C και αντίστροφα.

4 Αντικατάσταση Μπαταριών

- 1 Πατήστε ελαφρώς στο σημείο με το  προς την κατεύθυνση που δείχνουν τα βέλη για να σπρώξετε προς τα πίσω το καπάκι του ασύρματου τηλεχειριστηρίου. (Όπως φαίνεται στην εικόνα)
- 2 Βγάλτε τις παλιές μπαταρίες. (Όπως φαίνεται στην εικόνα)
- 3 Εισάγετε δύο νέες ξηρού τύπου μπαταρίες AAA 1,5V και δώστε προσοχή στην πολικότητα. (Όπως φαίνεται στην εικόνα)
- 4 Βάλτε το πίσω κάλυμμα του ασύρματου τηλεχειριστηρίου στη θέση του. (Όπως φαίνεται στην εικόνα)

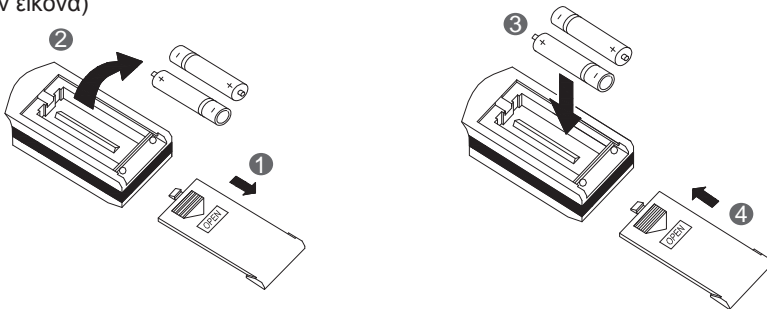

 **Σημειώσεις!**

- 1 Κατά την αλλαγή των μπαταριών, μην χρησιμοποιείτε παλιές ή διαφορετικές μεταξύ τους μπαταρίες, διαφορετικά μπορεί να προκληθεί δυσλειτουργία του ασύρματου τηλεχειριστηρίου.
- 2 Εάν το ασύρματο τηλεχειριστήριο δεν πρόκειται χρησιμοποιηθεί για αρκετό καιρό, βγάλτε τις μπαταρίες και μην επιτρέψετε διαρροή υγρού να προκαλέσει ζημία στο ασύρματο τηλεχειριστήριο.
- 3 Το τηλεχειριστήριο θα πρέπει να χρησιμοποιείται μέσα στα όρια της εμβέλειας λήψης του.
- 4 Θα πρέπει να τοποθετείται σε σημεία που απέχουν 1m από την TV ή το στερεοφωνικό.
- 5 Εάν το ασύρματο τηλεχειριστήριο δεν μπορεί να λειτουργήσει κανονικά, βγάλτε τις μπαταρίες, και μετά από 30 δευτερόλεπτα βάλτε τις μπαταρίες ξανά, αν δεν λειτουργούν κανονικά, αλλάξτε τις μπαταρίες.

Cuprins

1 Notificări pentru utilizator	13
2 Panoul de control al telecomenzii	13
3 Introducere pentru funcțiile speciale	16
4 Schimbarea bateriilor	17



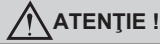

1 User notice



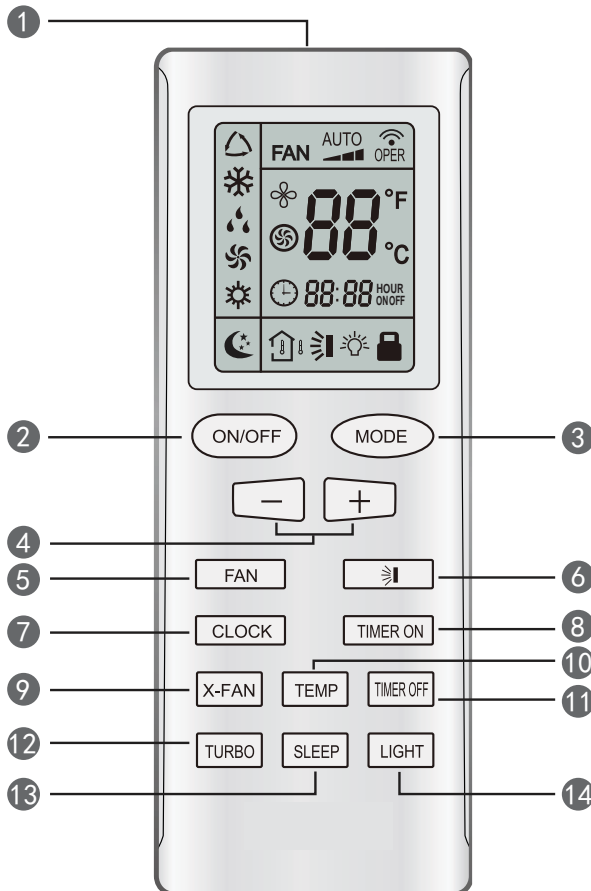

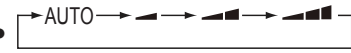











- ① Asigurați-vă că nu există obstrucții între telecomanda fără fir și receptorul de semnal.
- ② Distanța până la receptorul de semnal al telecomenzii wireless poate fi până la 10m.
- ③ Nu aruncați apă și nu stropiți niciodată telecomanda fără fir.
- ④ Nu lăsați niciun lichid să curgă peste telecomandă.
- ⑤ Nu expuneți niciodată telecomanda direct sub razele de soare sau în locuri cu temperaturi foarte ridicate.
- ⑥ Această telecomandă se poate folosi la diferite tipuri de aer condiționat. Asupra unor modele care nu dispun de funcțiile descrise aici, ne rezervăm dreptul de a nu informa în mod exclusiv.

2 Panoul de control al telecomenzii



Nr.	Denumire	Descrierea funcției
1	Transmițător de semnal	<ul style="list-style-type: none"> • Transmițător de semnal
2	Butonul ON/OFF	<ul style="list-style-type: none"> • Apăsați acest buton și aparatul se va deschide, mai apăsați o dată și unitatea se va închide. Când se pornește aparatul, funcția Sleep va fi anulată, însă timpul presetat rămâne fixat.
3	Butonul MODE	<ul style="list-style-type: none"> • La apăsarea acestui buton vor fi selectate circular funcțiile Auto, Cool, Dry, Fan, Heat. Regimul Auto este setat implicit după pornire. În modul auto, temperatura nu va mai fi afișată. În modul heat valoarea inițială este de 28°C (82°F). În alte moduri, valoarea inițială este de 25°C (77°F)  <p>△ AUTO ; ❄️ COOL ; 💧 DRY ; 🌀 FAN ; ☀️ HEAT (doar pentru unitățile cu regim de răcire și încălzire)</p>
4	Butonul -	<ul style="list-style-type: none"> • Temperatura presetată poate fi redusă apăsând acest buton. Apăsați acest buton și mențineți apăsat mai mult de două secunde: puteți schimba astfel temperatura repede, până la eliberarea butonului, și se va trimite comanda. Reglarea temperaturii nu este disponibilă în modul Auto însă comanda este trimisă dacă se apasă acest buton. Valoarea de setare a temperaturii în grade Celsius: 16-30, în grade Fahrenheit: 61-86.
	Butonul +	<ul style="list-style-type: none"> • Pentru creșterea temperaturii presetate, prin apăsarea și ținerea butonului apăsat mai mult de 2 secunde, temperatura poate fi schimbată rapid, până la eliberarea butonului, apoi se trimit informațiile. Reglarea temperaturii nu este disponibilă în modul Auto însă comanda este trimisă dacă se apasă acest buton. Valoarea de setare a temperaturii în grade Celsius: 16-30, în grade Fahrenheit: 61-86.
5	Butonul FAN	<ul style="list-style-type: none"> • La apăsare acestui buton vor fi selectate vitezele Auto, Low(scăzută), Middle(mijlocie), High(ridicată). După pornire, viteza ventilatorului Auto este cea implicită. În timpul regimului Dry viteza ventilatorului va fi viteza scăzută.  <p>  Low speed  Middle speed  High speed </p> <p>În modul Dry, ventilatorul va continua să funcționeze la viteză scăzută, iar viteza sa nu va putea fi reglată</p>

6	Butonul SWING UP/DOWN	<ul style="list-style-type: none"> Apăsați acest buton pentru a seta unghiul de oscilare, care se schimbă prin rotație după cum urmează:  Când fantele de ghidaj încep să oscileze sus-jos, dacă funcția swing este anulată, fanta se va opri și va rămâne în poziția curentă. Marcajul  indică faptul că fanta oscilează sus-jos între pozițiile din figura de mai sus. (Funcția swing simplificată pentru anumite modele: Când telecomanda wireless este pornită inițial, unitatea fiind în modul OFF de funcționare, funcția poate fi setată apăsând butonul + și butonul swing simultan, iar simbolul  va lumina intermitent de două ori. Apoi, după închiderea unității, funcția poate fi activată apăsând butonul swing, simbolul  arătând că funcția swing este activată. Lipsa simbolului indică faptul că funcția swing nu este activă).
7	Butonul CLOCK	<ul style="list-style-type: none"> Prin apăsarea butonului CLOCK,  licărește. În 5 secunde, prin apăsarea butonului + sau - se reglează timpul curent. Prin ținerea apăsată a butonului +/- mai mult de 2 secunde, timpul va crește sau se va reduce cu 10 minute la fiecare 0,5 secunde. În timpul licării după setare, apăsați din nou butonul CLOCK pentru a confirma setarea. Ora 12.00 este setată implicit, la activarea telecomenzii wireless.
8	Butonul TIMER ON	<ul style="list-style-type: none"> Când Timer on este activat: Semnalul „ON” va pâlpâi, iar simbolul  va dispărea. În decurs de 5 secunde, prin apăsarea butonului + sau - se poate ajusta valoarea ON a timpului. Fiecare apăsare va scădea sau crește timpul cu un minut. În plus, timpul poate fi setat și prin apăsarea constantă a butonului +/- . În primele 2,5 secunde, timpul va crește/scădea repede pe minut, iar în ultimele 2,5 secunde, timpul va crește/scădea pe 10 minute. După ce valoarea dorită este setată, apăsați TIMER ON din nou pentru a vă încadra în cele cinci secunde. După aceea, încă o apăsare pe TIMER ON va anula setarea. Anterior acestei setări, ceasul va fi reglat la valoarea curentă.
9	Butonul X-FAN	<ul style="list-style-type: none"> La apăsarea acestui buton, se poate activa sau dezactiva funcția X-FAN. În modul COOL sau DRY, apăsarea acestui buton determină apariția simbolului , care arată că funcția X-FAN este activată. Reapăsând acest buton, simbolul  dispăre, iar funcția este dezactivată. După activare, X-FAN OFF este implicit. Dacă unitatea este oprită, X-FAN nu poate fi dezactivat, însă poate fi activat.

10	Butonul TEMP	<ul style="list-style-type: none"> Prin apăsarea acestui buton, se poate selecta afișarea setărilor temperaturii la interior sau temperatura ambientală din interior. Temperatura ambientală din interior este setarea implicită, după ce unitatea este activată. Apăsând butonul TEMP, când este afișat simbolul , afișajul interior va arăta setările temperaturii interioare. Când este afișat simbolul , va arăta temperatura interioară ambientală, iar simbolul  desmnează o acțiune nevalidată. În cazul în care afișajul curent arată temperatura interioară ambientală. În cazul afișării temperaturii ambientale din interior, dacă se primește alt semnal, se va afișa temperatura presetată, 5s mai târziu va reveni pe afișaj temperatura ambientală. (Această funcție se aplică anumitor modele)
11	Butonul TIMER OFF	<ul style="list-style-type: none"> Dacă apăsați acest buton pentru a intra în setarea TIMER OFF, se vor urma aceiași pași ca în cazul setării pentru TIMER ON, numai că simbolul OFF va lumina intermitent de această dată.
12	Butonul TURBO	<ul style="list-style-type: none"> În modul de funcționare COOL sau HEAT, la apăsarea acestui buton, se poate porni sau opri funcția TURBO. După pornirea funcției TURBO, simbolul  va fi afișat. La schimbarea modului de funcționare sau la schimbarea vitezei de ventilare, această funcție va fi anulată automat (Această funcție se aplică anumitor modele)
13	Butonul SLEEP	<ul style="list-style-type: none"> La apăsarea acestui buton vor fi selectate regimurile Sleep On și Sleep Off. După conectarea la curent Sleep Off este implicit. După ce aparatul este închis regimul nocturn (Sleep) este anulat. După setarea regimului nocturn, semnalul Sleep  va fi afișat. În timpul regimurilor Fan sau Auto această funcție nu este valabilă
14	Butonul LIGHT	<ul style="list-style-type: none"> Apăsați butonul pentru a seta activarea- Light on și dezactivarea-Light off. Când funcția Light este activată, simbolul  va fi afișat, iar lumina de pe display va fi aprinsă. Când funcția Light este dezactivată, simbolul  va dispărea, iar lumina de pe display va fi stinsă.

3 Introducere pentru funcțiile speciale

- **Despre funcția X-FAN** (Această funcție este aplicabilă la anumite modele speciale)

Această funcție indică faptul că umezeala de pe evaporator a unității de la interior va fi eliminată după ce aparatul este oprit pentru a evita formarea mușcăiului.

- ① După oprirea unității prin apăsarea butonului ON/OFF, ventilatorul interior va continua să funcționeze câteva minute la viteză joasă. În acest interval, apăsați butonul X-FAN pentru a opri direct ventilatorul interior.
- ② Oprirea funcției X-FAN: După oprirea unității prin apăsarea butonului ON/OFF, unitatea se va opri în totalitate.

- **Despre funcția TURBO** (Această funcție este aplicabilă la anumite modele speciale)

Dacă porniți această funcție, aparatul va funcționa cu o viteză a ventilatorului foarte ridicată pentru răcire și încălzire rapidă astfel încât temperatura ambientală să se apropie de temperatura curentă cât mai curând posibil.

- **Despre regimul AUTO**

Când regimul Auto este selectat, temperatura setată nu va fi afișată pe ecranul LCD, aparatul va funcționa în funcție de temperatura camerei automat pentru a selecta metoda de funcționare adecvată și pentru un mediu confortabil.

- **Despre funcția lock (blocare)**

Apăsați butoanele + și – simultan pentru a bloca sau debloca tastatura. Dacă telecomanda este blocată, atunci va apărea afișajul , caz în care, dacă apăsați orice buton, semnalul va lumina intermitent de trei ori. Dacă tastatura este deblocată, afișajul va dispărea.

- **Despre funcția SWING UP/DOWN (OSCILARE SUS/JOS)**

- ① Apăsați butonul SWING UP/DOWN (OSCILARE SUS/JOS) pentru mai mult de 2 secunde și fantele vor începe să oscileze sus-jos. După eliberarea butonului, fantele se vor opri și își vor menține statutul curent.
- ② Când fantele încep să oscileze, apăsați butonul SWING UP/DOWN (OSCILARE SUS/JOS) timp de 2 secunde și fantele vor înceta oscilarea direct. Între timp, apăsând butonul în intervalul de 2 secunde, fantele își vor continua mișcarea de oscilare.

- **Despre schimbarea între grade Fahrenheit și Celsius**

Când unitatea este în modul OFF, apăsați butonul MODE și butonul  simultan pentru a schimba între gradele Celsius și Fahrenheit.

4 Schimbarea bateriilor

- ① Apăsați ușor butonul  în direcția săgeții, presând carcasa din spate a telecomenzii fără fir.
- ② Scoateți bateriile vehi.
- ③ Introduceți două baterii noi AAA1.5V, respectând semnele de polaritate
- ④ Reatașați carcasa din spate a telecomenzii

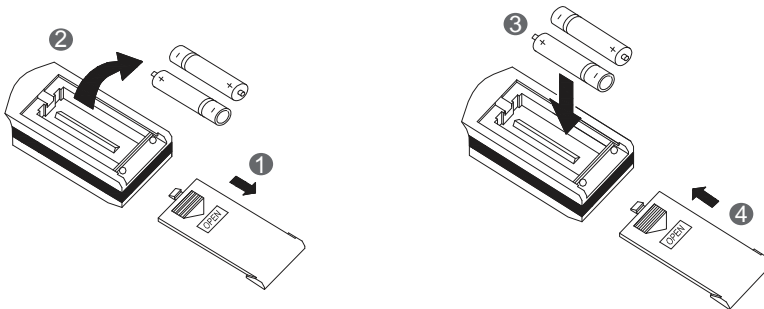

Notă!

- ① Când schimbați bateriile, nu utilizați baterii de alt tip, puteți cauza disfuncționalități Telecomenzii fără fir.
- ② Dacă nu veți utiliza telecomanda pentru o perioadă mai lungă de timp, scoateți bateriile, evitând astfel deteriorarea telecomenzii din cauza lichidului din baterii.
- ③ Utilizați telecomanda în aria de acțiune a emițătorului. 4.Telecomanda ar trebui utilizată la 1m distanță de televizor sau sisteme audio.
- ④ Dacă telecomanda nu funcționează normal, scoateți bateriile și reintroduceți-le după 30 de secunde. Dacă nici în această situație nu funcționează normal, înlocuiți-le.
- ⑤ Bateriile trebuie scoase din dispozitiv înainte de a ieși din uz. Bateriile trebuie reciclate în condiții de siguranță.



inventor[®]

Your-conditions

