

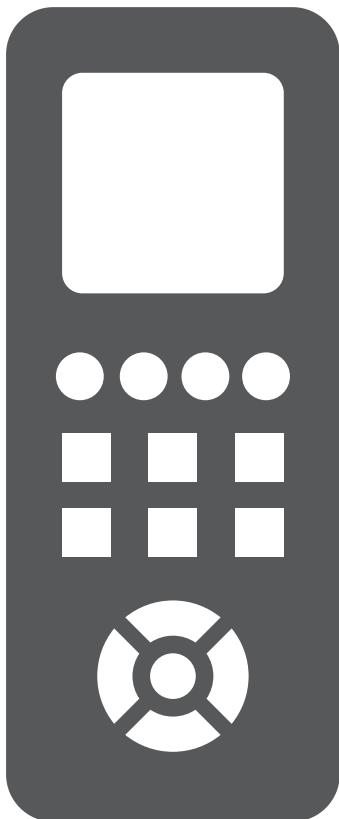

AIR CONDITIONING SYSTEMS REMOTE CONTROLLER

- **USER'S MANUAL**
- **ΕΓΧΕΙΡΙΔΙΟ ΧΡΗΣΗΣ**
- **MANUAL UTILIZATORULUI**



MODELS:

V5MCI32-18WiFiR/U5MRS32-18
V5MCI32-24WiFiR/U5MRS32-24
V5MCI32-36WiFiR/U5MRS32-36
V5MCI32-50WiFiR/U5MRT32-50
V5MCI32-60WiFiR/U5MRT32-60

V5MDI32-18WiFiR/U5MRS32-18
V5MDI32-24WiFiR/U5MRS32-24
V5MDI32-36WiFiR/U5MRS32-36
V5MDI32-50WiFiR/U5MRT32-50
V5MDI32-60WiFiR/U5MRT32-60

V5MKI32-24WiFiR/U5MRS32-24
V5MKI32-36WiFiR/U5MRS32-36
V5MKI32-50WiFiR/U5MRT32-50
V5MKI32-60WiFiR/U5MRT32-60



CONTENTS

Remote controller Specifications.....	3
Operation buttons	4
Indicators on LCD.....	7
How to use the buttons.....	8
Auto operation	8
Cooling/Heating/Fan operation	8
Dehumidifying operation.....	9
Adjusting air flow direction	9
Timer operation	10
Handling the remote controller	14

NOTE:

- Buttons design is based on typical model and might be slightly different from the actual one you purchased, the actual shape shall prevail.
- All the functions described are accomplished by the unit. If the unit has no this feature, there is no corresponding operation happened when press the relative button on the remote controller.
- When there are wide differences between “Remote controller Illustration” and “ USER’S MANUAL” on function description, the description of “USER’S MANUAL” shall prevail.

Remote Controller Specifications

Model	RG57A3/BGEF, RG57A2/BGEF, RG57B/BGE, RG57D/BGE
Rated Voltage	3.0V(Dry batteries R03/LR03X2)
Signal Receiving Range	8m
Environment	-5°C~60°C

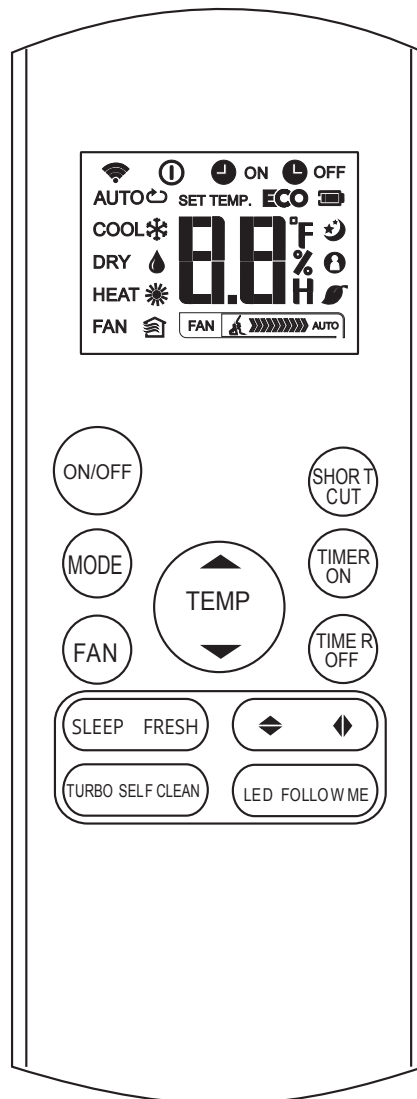

Operation of buttons

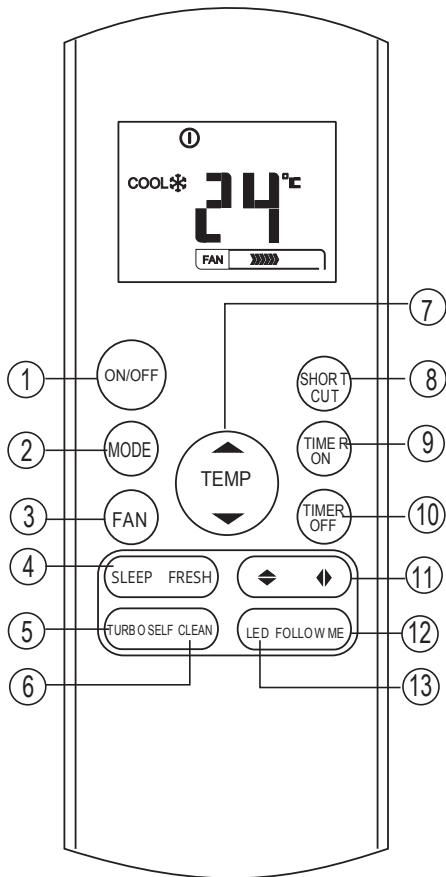

❶ ON/OFF Button

This button turns the air conditioner ON and OFF.

❷ MODE Button

Press this button to modify the air conditioner mode in a sequence of following:

→ AUTO → COOL → DRY → HEAT → FAN →

NOTE: Please do not select HEAT mode if the machine you purchased is cooling only type.

Heat mode is not supported by the cooling only appliance.

❸ FAN Button

Used to select the fan speed in four steps:

→ AUTO → LOW → MED → HIGH →

NOTE: You can not switch the fan speed in AUTO or DRY mode.

❹ SLEEP Button

- Active/Disable sleep function. It can maintain the most comfortable temperature and save energy. This function is available on COOL, HEAT or AUTO mode only .

- For the detail, see " sleep operation " in "USER'S MANUAL"

NOTE: While the unit is running under SLEEP mode, it would be cancelled if MODE, FAN SPEED or ON/OFF button is pressed.

FRESH Button (Not available)

❺ TURBO Button

Active/Disable Turbo function. Turbo function enables the unit to reach the preset temperature at cooling or heating operation in the shortest time (if the indoor unit does not support this function, there is no corresponding operation happened when pressing this button).

❻ SELF CLEAN Button (Not available)

Operation of buttons

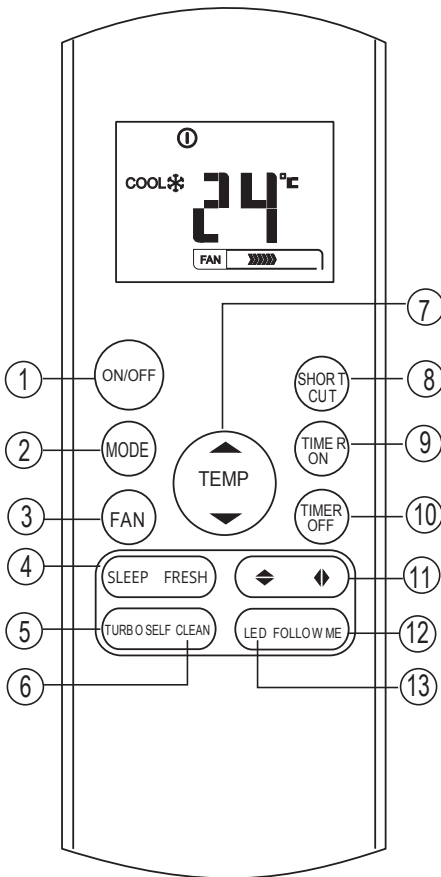

7 UP Button(▲)

Push this button to increase the indoor temperature setting in 1°C increments to 30°C.

DOWN Button(▼)

Push this button to decrease the indoor temperature setting in 1°C increments to 17°C.

NOTE: Temperature control is not available in Fan mode.

8 SHORTCUT Button

- Used to restore the current settings or resume previous settings.
- On the first time connecting to the power, if push the SHORTCUT button, the unit will operate on AUTO mode, 26°C, and fan speed is Auto.
- Push this button when remote controller is on, the system will automatically revert back to the previous settings including operating mode, setting temperature, fan speed level and sleep feature (if activated).
- If pushing more than 2 seconds, the system will automatically restore the current operation settings including operating mode, setting temperature, fan speed level and sleep feature (if activated).

9 TIMER ON Button

Press this button to initiate the auto-on time sequence. Each press will increase the auto-timed setting in 30 minutes increments. When the setting time displays 10.0, each press will increase the auto-timed setting 60 minutes increments.

To cancel the auto-timed program, simply adjust the auto-on time to 0.0.

10 TIMER OFF Button

Press this button to initiate the auto-off time sequence. Each press will increase the auto-timed setting in 30 minutes increments.

When the setting time displays 10.0, each press will increase the auto-timed setting 60 minutes increments. To cancel the auto-timed program, simply adjust the auto-off time to 0.0

Operation of buttons

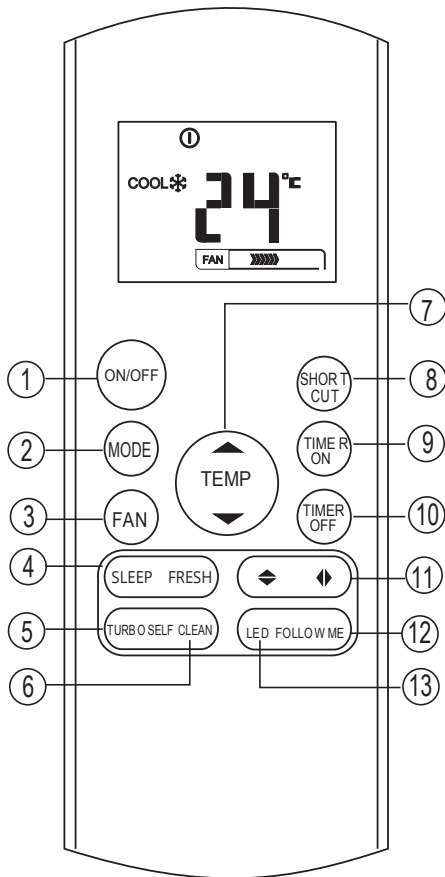

⑪ Swing ⇄ Button

Used to stop or start horizontal louver movement or set the desired up/down air flow direction. The louver changes 6 degree in angle for each press. If keep pushing more than 2 seconds, the louver will swing up and down automatically.

Swing ⇄ Button

It is not available for these series.

⑫ FOLLOW ME Button

(This feature is not available for Floor Standing Units)
Push this button to initiate the Follow Me feature, the remote display is actual temperature at its location. The remote control will send this signal to the air conditioner every 3 minutes interval until press the Follow Me button again. The air conditioner will cancel the Follow Me feature automatically if it does not receive the signal during any 7 minutes interval.

⑬ LED Button

Disable/Active indoor screen Display. When pushing the button, the indoor screen display is cleared, press it again to light the display.

Indicators on LCD

Information are displayed when the remote controller is powered up.

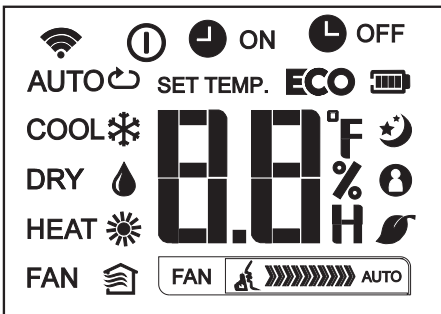

Mode display

AUTO COOL DRY
HEAT FAN

- Displayed when data transmitted.
- Displayed when remote controller is ON.
- Battery display (low battery detection)
- ECO** Not available for this unit

- ON Displayed when TIMER ON time is set.
- OFF Displayed when TIMER OFF time is set.
- Show set temperature or room temperature, or time under TIMER setting.

- Displayed in Sleep Mode operation.
- Indicated that the air conditioner is operating in Follow me mode
- Not available for this unit
- Not available for this unit

Fan speed indication

- FAN Low speed
- FAN Medium speed
- FAN High speed
- FAN Auto fan speed

Note:

All indicators shown in the figure are for the purpose of clear presentation. But during the actual operation only the relative functional signs are shown on the display window.

How to use the buttons

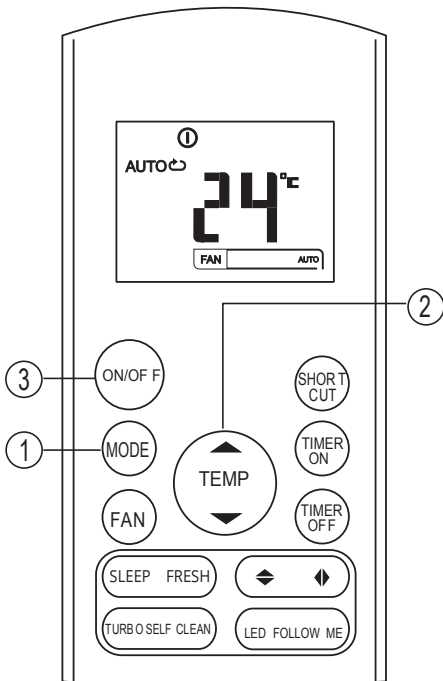

Auto operation

Ensure the unit is plugged in and power is available. The OPERATION indicator on the display panel of the indoor unit starts flashing.

1. Press the **MODE** button to select Auto.
2. Press the **UP/DOWN** button to set the desired temperature. The temperature can be set within a range of 17°C~ 30°C in 1 °C increments.
3. Press the **ON/OFF** button to start the air conditioner.

NOTE

1. In the Auto mode, the air conditioner can logically choose the mode of Cooling, Fan, and Heating by sensing the difference between the actual ambient room temperature and the setting temperature on the remote controller.
2. In the Auto mode, you can not switch the fan speed. It has already been automatically controlled.
3. If the Auto mode is not comfortable for you, the desired mode can be selected manually.

Cooling /Heating/Fan operation

Ensure the unit is plugged in and power is available.

1. Press the **MODE** button to select COOL, HEAT(cooling & heating models only) or FAN mode.
2. Press the **UP/DOWN** buttons to set the desired temperature. The temperature can be set within a range of 17°C~ 30°C in 1 °C increments.
3. Press the **FAN** button to select the fan speed in four steps-Auto, Low, Med, or High.
4. Press the **ON/OFF** button to start the air conditioner.

NOTE

In the FAN mode, the setting temperature is not displayed in the remote controller and you are not able to control the room temperature either. In this case, only step 1, 3 and 4 may be performed.

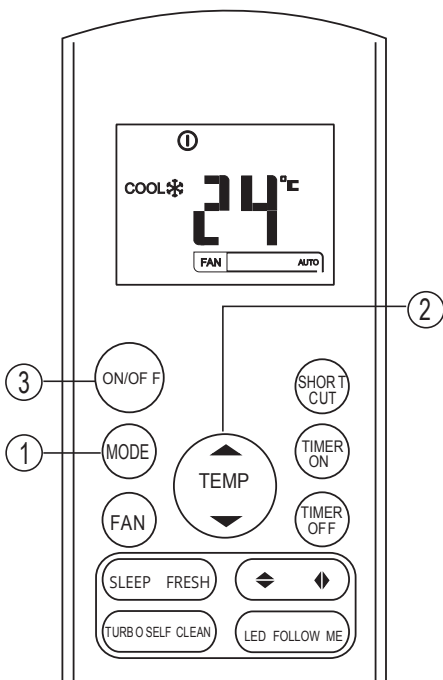

How to use the buttons

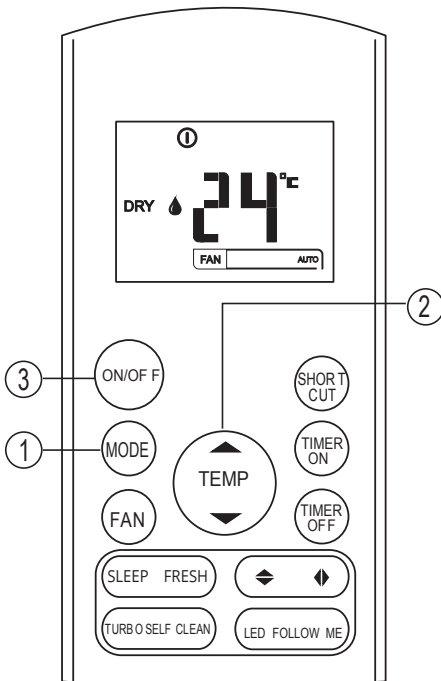

Dehumidifying operation

Ensure the unit is plugged in and power is available. The OPERATION indicator on the display panel of the indoor unit starts flashing.

1. Press the **MODE** button to select DRY mode.
2. Press the **UP/DOWN** buttons to set the desired temperature. The temperature can be set within a range of 17°C~ 30°C in 1°C increments.
3. Press the **ON/OFF** button to start the air conditioner.

NOTE

In the Dehumidifying mode, you can not switch the fan speed. It has already been automatically controlled.

Adjusting air flow direction

(available only for Floor/Ceiling units)

Use the **SWING**  button to adjust the desired airflow direction.

Up/Down direction can be adjusted with the  button on the remote controller. Each time when you press the button, the louver moves an angle of 6 degree. If pressing more than 2 seconds, the louver will swing up and down automatically.

NOTE

When the louver swing or move to a position which would affect the cooling or heating effect of the air conditioner, it would automatically change the swing/moving direction.

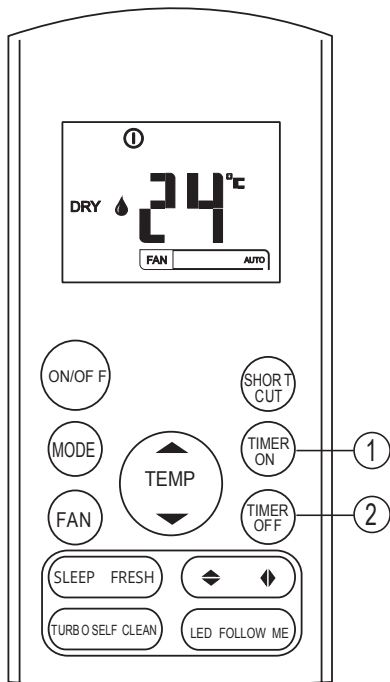

Timer operation

Press the TIMER ON button can set the auto-on time of the unit. Press the TIMER OFF button can set the auto-off time of the unit.

To set the Auto-on time.

1. Press the TIMER ON button. The remote controller shows TIMER ON, the last Auto-on setting time and the signal "H" will be shown on the LCD display area. Now it is ready to reset the Auto-on time to START the operation.
2. Push the TIMER ON button again to set desired Auto-on time. Each time you press the button, the time increases by half an hour between 0 and 10 hours and by one hour between 10 and 24 hours.
3. After setting the TIMER ON, there will be a one second delay before the remote controller transmits the signal to the air conditioner. Then, after approximately another 2 seconds, the signal "h" will disappear and the set temperature will re-appear on the LCD display window.

To set the Auto-off time.

1. Press the TIMER OFF button. The remote controller shows TIMER OFF, the last Auto-off setting time and the signal "H" will be shown on the LCD display area. Now it is ready to reset the Auto-off time to stop the operation.
2. Push the TIMER OFF button again to set desired Auto-off time. Each time you press the button, the time increases by half an hour between 0 and 10 hours and by one hour between 10 and 24 hours.
3. After setting the TIMER OFF, there will be a one second delay before the remote controller transmits the signal to the air conditioner. Then, after approximately another 2 seconds, the signal "H" will disappear and the set temperature will re-appear on the LCD display window.

⚠ CAUTION

- When you select the timer operation, the remote controller automatically transmits the timer signal to the indoor unit for the specified time. Therefore, keep the remote controller in a location where it can transmit the signal to the indoor unit properly.
- The effective operation time set by the remote controller for the timer function is limited to the following settings: 0.5, 1.0, 1.5, 2.0, 2.5, 3.0, 3.5, 4.0, 4.5, 5.0, 5.5, 6.0, 6.5, 7.0, 7.5, 8.0, 8.5, 9.0, 9.5, 10, 11, 12, 13, 14, 15, 16, 17, 18, 19, 20, 21, 22, 23 and 24.

Example of timer setting

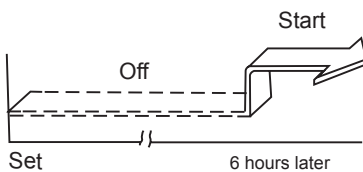
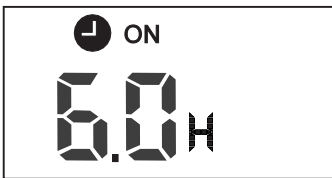

TIMER ON (Auto-on Operation)

The TIMER ON feature is useful when you want the unit to turn on automatically before you return home. The air conditioner will automatically start operating at the set time.

Example:

To start the air conditioner in 6 hours.

1. Press the TIMER ON button, the last setting of starting operation time and the signal "H" will show on the display area.
2. Press the TIMER ON button to display "6.0H" on the TIMER ON display of the remote controller.
3. Wait for 3 seconds and the digital display area will show the temperature again. The "TIMER ON" indicator remains on and this function is activated.

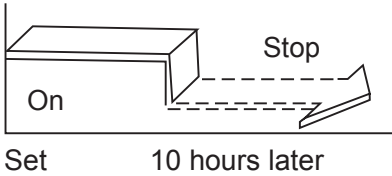
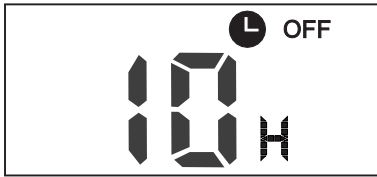

TIMER OFF (Auto-off Operation)

The TIMER OFF feature is useful when you want the unit to turn off automatically after you go to bed. The air conditioner will stop automatically at the set time.

Example:

To stop the air conditioner in 10 hours.

1. Press the TIMER OFF button, the last setting of stopping operation time and the signal "H" will show on the display area.
2. Press the TIMER OFF button to display "10H" on the TIMER OFF display of the remote controller.
3. Wait for 3 seconds and the digital display area will show the temperature again. The "TIMER OFF" indicator remains on and this function is activated.

COMBINED TIMER

(Setting both ON and OFF timers simultaneously)

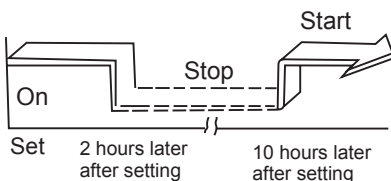
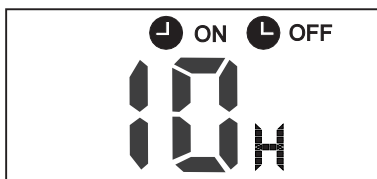

TIMER OFF → TIMER ON

(On → Stop → Start operation)

This feature is useful when you want to stop the air conditioner after you go to bed, and start it again in the morning when you wake up or when you return home.

Example:

To stop the air conditioner 2 hours after setting and start it again 10 hours after setting.

1. Press the TIMER OFF button.
2. Press the TIMER OFF button again to display 2.OH on the TIMER OFF display.
3. Press the TIMER ON button.
4. Press the TIMER ON button again to display 10H on the TIMER ON display .
5. Wait for 3 seconds and the digital display area will show the temperature again. The "TIMER ON OFF" indicator remains on and this function is activated.

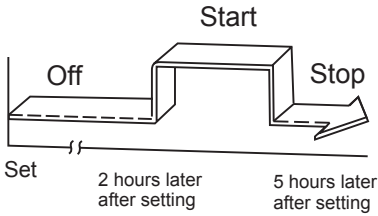
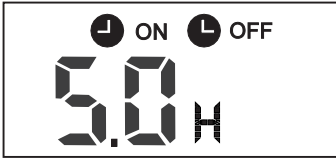

TIMER ON → TIMER OFF

(Off → Start → Stop operation)

This feature is useful when you want to start the air conditioner before you wake up and stop it after you leave the house.

Example:

To start the air conditioner 2 hours after setting, and stop it 5 hours after setting.

1. Press the TIMER ON button.
2. Press the TIMER ON button again to display 2.OH on the TIMER ON display.
3. Press the TIMER OFF button.
4. Press the TIMER OFF button again to display 5.OH on the TIMER OFF display .
5. Wait for 3 seconds and the digital display area will show the temperature again. The "TIMER ON & TIMER OFF" indicator remains on and this function is activated.

Handling the remote controller

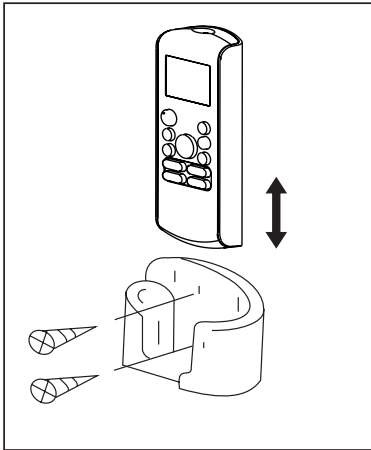
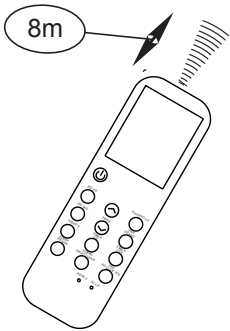
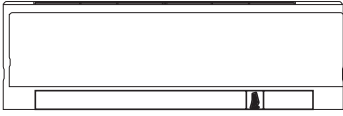

Location of the remote controller.

- Use the remote controller within a distance of 8 meters from the appliance, pointing it towards the receiver. Reception is confirmed by a beep.

⚠ CAUTION

- The air conditioner will not operate if curtains, doors or other materials block the signals from the remote controller to the indoor unit.
- Prevent any liquid from falling into the remote controller. Do not expose the remote controller to direct sunlight or heat.
- If the infrared signal receiver on the indoor unit is exposed to direct sunlight, the air conditioner may not function properly. Use curtains to prevent the sunlight from falling on the receiver.
- If other electrical appliances react to the remote controller, either move these appliances or consult your local dealer.
- Do not drop the remote controller. Handle with care.
- Do not place heavy objects on the remote controller, or step on it.

Using the remote controller holder (optional)

- The remote controller can be attached to a wall or pillar by using a remote controller holder(not supplied, purchased separately).
- Before installing the remote controller, check that the air conditioner receives the signals properly.
- Install the remote controller with two screws.
- For installing or removing the remote controller, move it up or down in the holder.

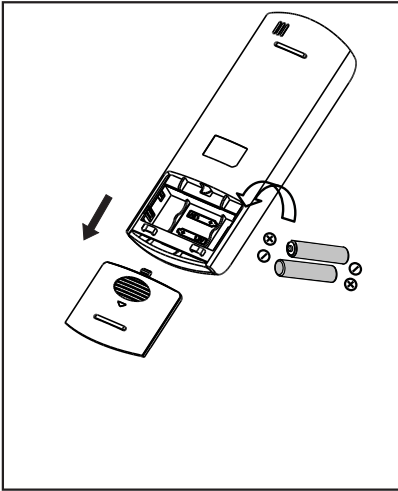

Replacing batteries

The following cases signify exhausted batteries. Replace old batteries with new ones.

- Receiving beep is not emitted when a signal is transmitted.
- Indicator fades away.

The remote controller is powered by two dry batteries (R03/LR03X2) housed in the back rear part and protected by a cover.

- (1) Remove the cover in the rear part of the remote controller.
- (2) Remove the old batteries and insert the new batteries, placing the (+) and (-) ends correctly.
- (3) Install the cover back on.

NOTE

When the batteries are removed, the remote controller erases all programming. After inserting new batteries, the remote controller must be reprogrammed.

▲ CAUTION

- Do not mix old and new batteries or batteries of different types.
- Do not leave the batteries in the remote controller if they are not going to be used for 2 or 3 months.
- Do not dispose batteries as unsorted municipal waste. Collection of such waste separately for special treatment is necessary.

ΠΕΡΙΕΧΟΜΕΝΑ

Χαρακτηριστικά του Ασύρματου Τηλεχειριστηρίου	3
Λειτουργίες Πλήκτρων	4
Ενδείξεις στην LCD Οθόνη	7
Χρήση των πλήκτρων	8
Αυτόματη Λειτουργία	8
Λειτουργίες Ψύξης/Θέρμανσης/Ανεμιστήρα.....	8
Λειτουργία Αφύγρανσης.....	9
Λειτουργία Timer	10
Χειρισμός του Ασύρματου Τηλεχειριστηρίου	14

Σημείωση:

- Ο σχεδιασμός των πλήκτρων μπορεί να διαφέρει ελαφρά από αυτό που έχετε αγοράσει
- Όλες οι λειτουργίες που περιγράφονται στο παρόν εγχειρίδιο υποστηρίζονται από την μονάδα. Αν η μονάδα δεν υποστηρίζει κάποιο χαρακτηριστικό, όταν πιέζετε το αντίστοιχο κουμπί στο τηλεχειριστήριο δεν θα υπάρχει αντίστοιχη λειτουργία.
- Όταν υπάρχουν ουσιαστικές διαφορές μεταξύ του παρόντος εγχειριδίου και του εγχειριδίου χρήσης. Υπερισχύει η ανάλυση λειτουργιών τους εγχειριδίου χρήσης της κλιματιστικής μονάδας.

Χαρακτηριστικά Ασύρματου Τηλεχειριστηρίου

Μοντέλο	RG57A3/BGEF, RG57A2/BGEF, RG57B/BGE, RG57D/BGE
Ονομαστική Τάση	3.0V (Μπαταρίεςστεγνού τύπου R03/LR03X2)
Εμβέλεια Σήματος Λήψης	8m
Εύρος θερμοκρασίας περιβάλλοντος	-5°C~ 60°C

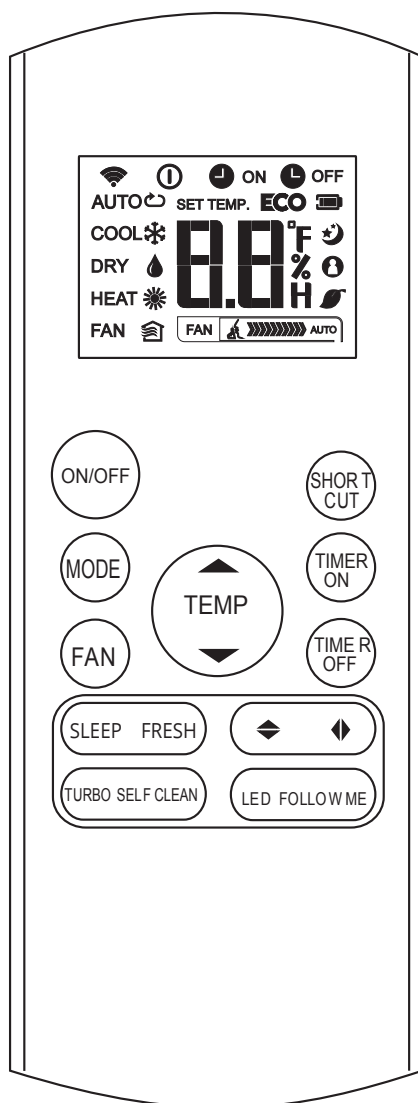

Λειτουργίες Πλήκτρων

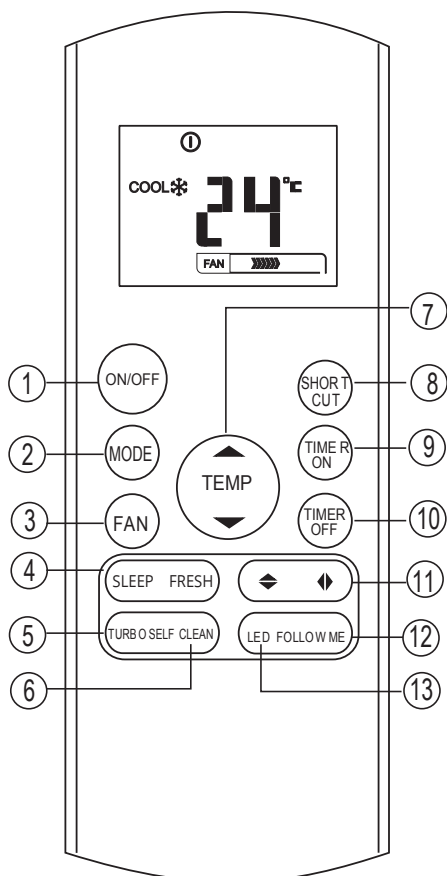

❶ Πλήκτρο ON/OFF

Με αυτό το πλήκτρο γίνεται η εκκίνηση και η διακοπή της λειτουργίας της κλιματιστικής μονάδας.

❷ Πλήκτρο MODE

Με αυτό το πλήκτρο ρυθμίζετε την λειτουργία της κλιματιστικής μονάδας όπως παρακάτω:

→ AUTO → COOL → DRY → HEAT → FAN →

→ (Αυτόματο) → (Ψύξη) → (Αφύγρανση) → (Ανεμιστήρας)

Σημείωση: Η λειτουργία θέρμανσης δεν ισχύει για τις μονάδες που είναι μόνο για Ψύξη.

❸ Πλήκτρο FAN

Με αυτό το πλήκτρο μπορείτε να επιλέξετε την ταχύτητα του ανεμιστήρα όπως παρακάτω:

→ AUTO → LOW → MED → HIGH →

Σημείωση: Η ρύθμιση της ταχύτητας του ανεμιστήρα ισχύει μόνο για τις λειτουργίες AUTO και DRY.

❹ Πλήκτρο SLEEP

- Η λειτουργία διατηρεί ευχάριστη την ατμόσφαιρα και συνεισφέρει στην εξοικονόμηση ενέργειας. Η ενεργοποίηση της συγκεκριμένης λειτουργίας είναι διαθέσιμη μόνο κατά την λειτουργία της ψύξης, θέρμανσης και στην Αυτόματη λειτουργία της κλιματιστικής μονάδας.
- Για περισσότερες λεπτομέρειες ανατρέξτε στο εγχειρίδιο λειτουργίας χρήσης

Σημείωση: Όταν η μονάδα λειτουργεί σε κατάσταση SLEEP αν πιέσετε τα πλήκτρα MODE, FAN SPEED ή ON/OFF η λειτουργία θα απενεργοποιηθεί.

Πλήκτρο FRESH (δεν διατίθεται)

❺ Πλήκτρο TURBO

Η λειτουργία Turbo επιτρέπει στη μονάδα να φτάσει την προκαθορισμένη θερμοκρασία σε λειτουργία ψύξης ή θέρμανσης στο συντομότερο χρόνο.

❻ Πλήκτρο SELF CLEAN (δεν διατίθεται)

Λειτουργίες Πλήκτρων

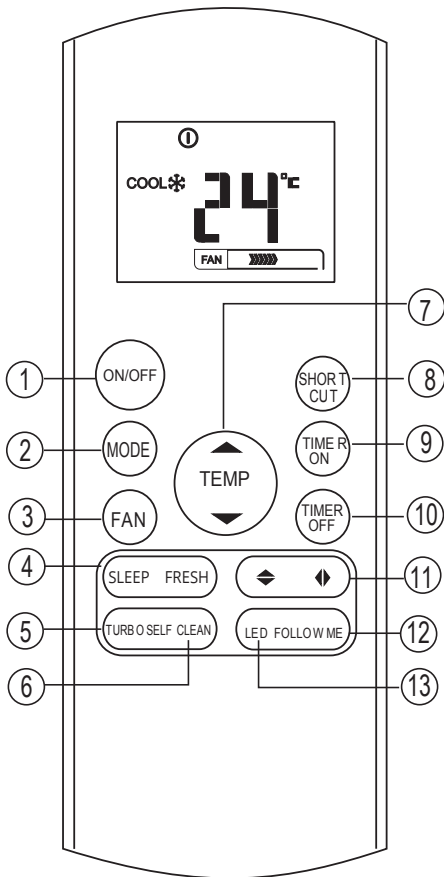

7 Πλήκτρο (▲)

Πιέστε αυτό το κουμπί για να αυξήσετε την εσωτερική ρύθμιση της θερμοκρασίας σε βήματα 1°C έως 30°C.

Πλήκτρο (▼)

Πιέστε αυτό το κουμπί για να μειώσετε την εσωτερική ρύθμιση της θερμοκρασίας σε βήματα 1°C έως 17°C.

Σημείωση: Η λειτουργία του έλεγχου της θερμοκρασίας δεν είναι διαθέσιμος σε λειτουργία ανεμιστήρα.

8 Πλήκτρο SHORTCUT

- Χρησιμοποιείται για να επαναφέρει τις τρέχουσες ρυθμίσεις ή να ξαναρχίσει τις προηγούμενες. Όταν θα το συνδεθεί για πρώτη φορά με το ρεύμα, αν πατήσετε το κουμπί SHORTCUT, η μονάδα θα μπει σε αυτόματη λειτουργία, 26°C και η ταχύτητα του ανεμιστήρα είναι επίσης αυτόματη.
- Πατήστε αυτό το κουμπί όταν το τηλεχειριστήριο είναι ενεργοποιημένο, το σύστημα αυτόματα θα επιστρέψει στις προηγούμενες ρυθμίσεις συμπεριλαμβανομένων της λειτουργίας, ρυθμίσεων θερμοκρασίας, επίπεδο ταχύτητας ανεμιστήρα και λειτουργία ύπνου (αν είναι ενεργοποιημένη).
- Αν κρατήσετε πατημένο πάνω από 2 δευτερόλεπτα, το σύστημα αυτόματα θα επανέλθει στις τρέχουσες ρυθμίσεις λειτουργίας συμπεριλαμβανομένων της λειτουργίας, των ρυθμίσεων θερμοκρασίας, επιπέδου ταχύτητας ανεμιστήρα και λειτουργία ύπνου (αν είναι ενεργοποιημένη).

9 Πλήκτρο TIMER ON

Πιέστε αυτό το πλήκτρο για να ενεργοποιήσετε την ρύθμιση της αυτόματης ενεργοποίησης. Κάθε φορά που πιέζετε αυτό το πλήκτρο η ρύθμιση της ώρας αυξάνεται κατά μισή ώρα έως τις 10 ώρες και κατά 1 ώρα έως τις 24 ώρες. Για να ακυρώσετε τη ρύθμιση, πιέστε το πλήκτρο μέχρι η ένδειξη της ώρας να γίνει 0.0.

10 Πλήκτρο TIMER OFF

Πιέστε αυτό το πλήκτρο για να ενεργοποιήσετε την ρύθμιση της αυτόματης απενεργοποίησης. Κάθε φορά που πιέζετε αυτό το πλήκτρο η ρύθμιση της ώρας αυξάνεται κατά μισή ώρα έως τις 10 ώρες και κατά 1 ώρα έως τις 24 ώρες. Για να ακυρώσετε τη ρύθμιση, πιέστε το πλήκτρο μέχρι η ένδειξη της ώρας να γίνει 0.0.

Λειτουργίες Πλήκτρων

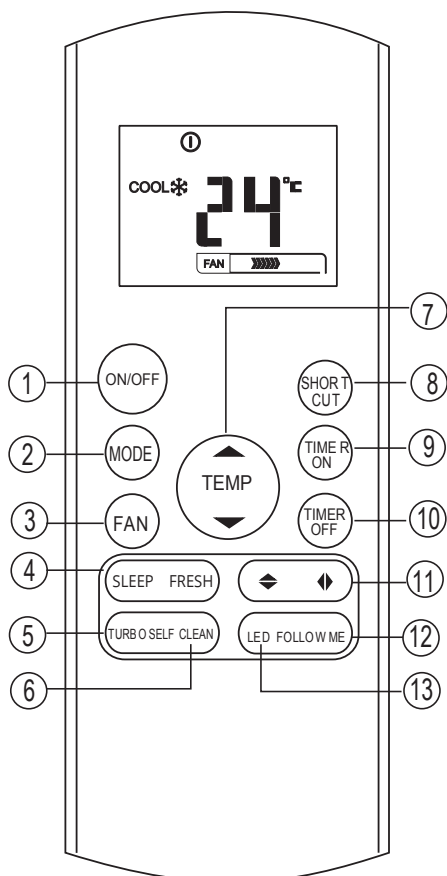

❶ Πλήκτρο Swing

Με αυτό το πλήκτρο επιλέγετε την εκκίνηση ή διακοπή της κίνησης της οριζόντιας περσίδας ή ρυθμίζετε την επιθυμητή θέση των περσίδων και την διάχυση αέρα.

Οι περσίδες αλλάζουν θέση κατά 6 μοίρες κάθε φορά που πιέζετε το πλήκτρο. Αν κρατήσετε πατημένο το πλήκτρο για περισσότερο από 2 δευτερόλεπτα οι περσίδες θα κινηθούν αυτόματα πάνω και κάτω.

Πλήκτρο Swing

Δεν διατίθεται σε αυτές τις σειρές.

❷ Πλήκτρο FOLLOW ME

(Δεν διατίθεται στις Ντουλάπες Εμφανούς Τύπου)
Πιέστε αυτό το πλήκτρο για να ενεργοποιήσετε την λειτουργία FOLLOW ME, στην οθόνη του τηλεχειριστηρίου εμφανίζεται η πραγματική θερμοκρασία στη θέση που βρίσκεται. Το τηλεχειριστήριο θα στείλει αυτό το μήνυμα στο κλιματιστικό σε κάθε χρονικό διάστημα 3 λεπτών έως ότου πατήσετε ξανά το κουμπί FOLLOW ME. Ο αέρας στο κλιματιστικό θα ακυρώσει τη λειτουργία FOLLOW ME αυτόματα αν δεν λάβει το σήμα μέσα σε διάστημα 7 λεπτών.

❸ Πλήκτρο LED

Απενεργοποίηση /Ενεργοποίηση εσωτερικής οθόνης. Πιέζοντας αυτό το πλήκτρο, η οθόνη απενεργοποιείται, πατήστε το ξανά για να ανάψει η οθόνη.

Ενδείξεις στην LCD οθόνη

Οι ενδείξεις εμφανίζονται όταν το τηλεχειριστήριο είναι ενεργοποιημένο

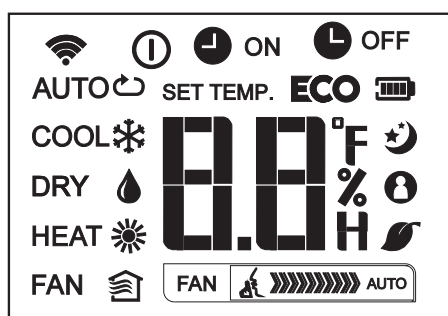

Ενδείξεις λειτουργιών

AUTO COOL DRY
HEAT FAN

- Ένδειξη μετάδοσης εντολών
- Εμφανίζεται όταν το τηλεχειριστήριο είναι ενεργοποιημένο
- Ένδειξη μπαταρίας (ανίχνευση χαμηλής μπαταρίας)
- ECO** Δεν είναι διαθέσιμο σε αυτή τη μονάδα

- ON Εμφανίζεται όταν το TIMER ON έχει ρυθμιστεί
- OFF Εμφανίζεται όταν το TIMER OFF έχει ρυθμιστεί
- Εμφανίζεται η θερμοκρασία που έχει οριστεί ή η θερμοκρασία του δωματίου ή εμφανίζεται ο χρόνος όταν ρυθμίζετε το TIMER

- Εμφανίζονται κατά τη λειτουργία Sleep
- Εμφανίζεται όταν το κλιματιστικό είναι σε κατάσταση λειτουργίας Follow me
- Δεν είναι διαθέσιμο σε αυτή τη μονάδα
- Δεν είναι διαθέσιμο σε αυτή τη μονάδα

Ενδείξεις ταχύτητας ανεμιστήρα

- FAN Χαμηλή ταχύτητα
- FAN Μεσαία ταχύτητα
- FAN Υψηλή ταχύτητα
- FAN Αυτόματη ταχύτητα

Σημείωση:

Οι ενδείξεις που περιγράφονται στο παρόν εγχειρίδιο είναι αναφορικές. Κατά την πραγματική λειτουργία στην οθόνη θα εμφανίζονται οι πραγματικές ενδείξεις

Χρήση των πλήκτρων

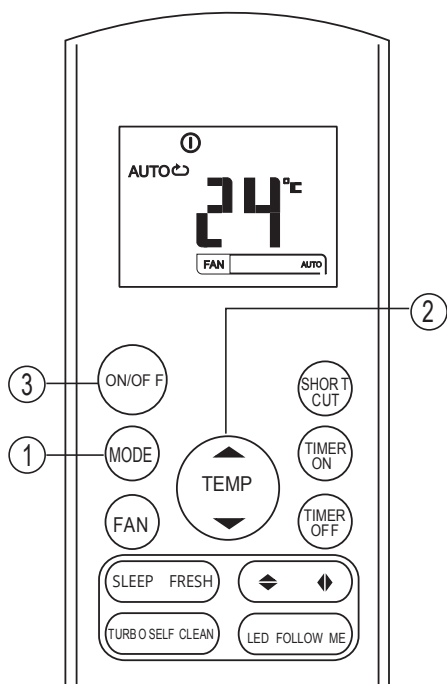

Αυτόματες λειτουργίες

Βεβαιωθείτε πως η κλιματιστική μονάδα είναι συνδεδεμένη με την παροχή ρεύματος. Η ενδεικτική λυχνία OPERATION (λειτουργίας) στην οθόνη της εσωτερικής μονάδας είναι αναμμένη.

1. Πιέστε το πλήκτρο **MODE** και επιλέξτε Auto.
2. Πιέστε το πλήκτρο **UP/DOWN** για να ορίσετε την επιθυμητή θερμοκρασία. Η θερμοκρασία μπορεί να ρυθμιστεί εντός του εύρους 17°C~ 30°C με αύξηση κατά 1°C.
3. Πιέστε το πλήκτρο **ON/OFF** για να ξεκινήσει η λειτουργία της κλιματιστικής μονάδας.

ΣΗΜΕΙΩΣΗ

1. Όταν έχετε επιλέξει την κατάσταση Auto, η κλιματιστική μονάδα επιλέγει αυτόματα τη λειτουργία ψύξης, θέρμανσης, ανεμιστήρα και αφύγρανσης ανάλογα με τη διαφορά θερμοκρασίας μεταξύ της θερμοκρασίας χώρου και της επιλεγμένης θερμοκρασίας.
2. Κατά την λειτουργία Auto δεν μπορείτε να επιλέξετε την ταχύτητα του ανεμιστήρα, έχει επιλεγεί αυτόματα.
3. Εάν η λειτουργία Auto δεν είναι η κατάλληλη για εσάς, μπορείτε να επιλέξετε χειροκίνητα την επιθυμητή κατάσταση λειτουργίας.

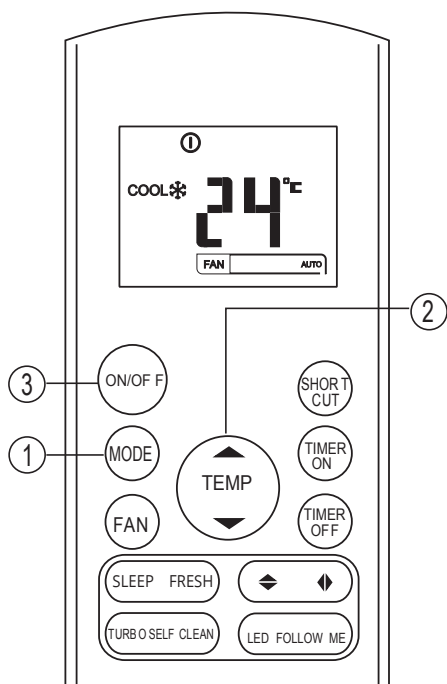

Λειτουργίες Ψύξης/Θέρμανσης/Ανεμιστήρα

Βεβαιωθείτε πως η κλιματιστική μονάδα είναι συνδεδεμένη με την παροχή ρεύματος.

1. Πιέστε το πλήκτρο **MODE** για να επιλέξετε τη λειτουργία ψύξης, θέρμανσης ή ανεμιστήρα.
2. Πιέστε το πλήκτρο **UP/DOWN** για να ορίσετε την επιθυμητή θερμοκρασία. Η θερμοκρασία μπορεί να ρυθμιστεί εντός του εύρους 17°C~ 30°C με αύξηση κατά 1°C.
3. Πιέστε το πλήκτρο **FAN** για να επιλέξετε την ταχύτητα του ανεμιστήρα.
4. Πιέστε το πλήκτρο **ON/OFF** για να ξεκινήσει η λειτουργία της κλιματιστικής μονάδας.

ΣΗΜΕΙΩΣΗ

Κατά τη λειτουργία FAN (ανεμιστήρας), δεν θα εμφανίζεται στο τηλεχειριστήριο η επιλεγμένη θερμοκρασία και δεν θα μπορείτε να ελέγξετε τη θερμοκρασία του χώρου. Σε αυτή την περίπτωση μπορείτε να ακολουθήσετε τα βήματα 1, 3 και 4.

Χρήση των πλήκτρων

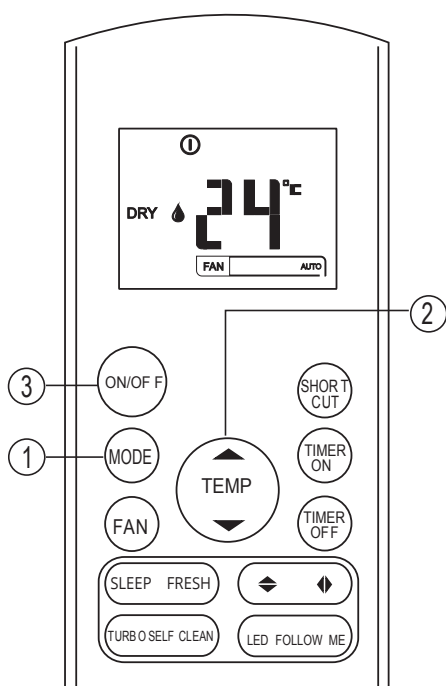

Λειτουργία Αφύγρανσης

Βεβαιωθείτε πως η κλιματιστική μονάδα είναι συνδεδεμένη με την παροχή ρεύματος. Η ενδεικτική λυχνία OPERATION (λειτουργίας) στην οθόνη της εσωτερικής μονάδας θα είναι αναμμένη.

1. Πιέστε το πλήκτρο **MODE** για να επιλέξετε την λειτουργία OKY.
2. Πιέστε το πλήκτρο **UP/DOWN** για να επιλέξετε την επιθυμητή θερμοκρασία. Η θερμοκρασία μπορεί να ρυθμιστεί εντός του εύρους 17°C~ 30°C με αύξηση κατά 1°C.
3. Πιέστε το πλήκτρο **ON/OFF** για να ξεκινήσει η λειτουργία της κλιματιστικής μονάδας

ΣΗΜΕΙΩΣΗ

Κατά τη λειτουργία αφύγρανσης, δεν μπορείτε να επιλέξετε ταχύτητα ανεμιστήρα. Έχει επιλεγεί αυτόματα.

Ρύθμιση της κατεύθυνσης της ροής του αέρα

(διατίθεται στις μονάδες Δαπέδου/Οροφής)

Χρησιμοποιήστε το πλήκτρα **SWING**  για να ορίσετε την επιθυμητή κατεύθυνση της ροής του αέρα.

1. Up / Down κατεύθυνση: μπορεί να ρυθμιστεί με το κουμπί  στο τηλεχειριστήριο. Κάθε φορά που πιέζετε το κουμπί, η περσίδα κινείται σε γωνία 6 μοιρών. Αν πατήσετε πάνω από 2 δευτερόλεπτα, η περσίδα ταλαντεύεται πάνω και κάτω αυτόματα.

ΣΗΜΕΙΩΣΗ

Όταν η κίνηση των περσίδων ή όταν η επιλογή μιας θέσης επηρεάζει την ψυκτική και θερμική απόδοση της κλιματιστικής μονάδας, τότε η ίδια η μονάδα θα αλλάξει αυτόματα την κατεύθυνση της ροής του αέρα.

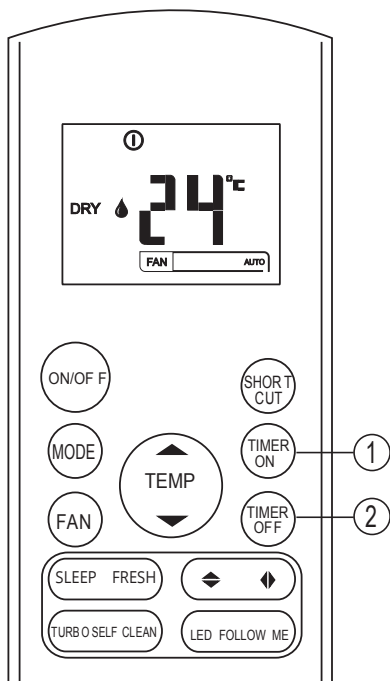

Λειτουργία Timer

Με το πλήκτρο TIMER ON μπορείτε να ρυθμίσετε την αυτόματη ενεργοποίηση της μονάδας και με το πλήκτρο TIMER OFF την αυτόματη απενεργοποίηση της μονάδας.

Ρύθμιση της ώρας της αυτόματης ενεργοποίησης της μονάδας.

1. Πιέστε το πλήκτρο TIMER ON. Στην οθόνη του ασύρματου τηλεχειριστηρίου θα εμφανιστεί η ένδειξη TIMER ON, η προηγούμενη ρύθμιση της ώρας που είχε γίνει και η ένδειξη "H". Τώρα μπορείτε να ρυθμίσετε την νέα ώρα αυτόματης ενεργοποίησης της μονάδας.
2. Πιέστε άλλη μια φορά το πλήκτρο TIMER ON για να ορίσετε την επιθυμητή ώρα της αυτόματης ενεργοποίησης της μονάδας. Κάθε φορά που πιέζετε το συγκεκριμένο πλήκτρο η ώρα θα αυξάνεται κατά 30λεπτά έως τις 10ώρες και έπειτα κατά 1 ώρα έως τις 24 ώρες.
3. Αφού ολοκληρώσετε τη ρύθμιση του TIMER ON, θα υπάρξει μια χρονοκαθυστέρηση ενάμιση δευτερολέπτου για την μετάδοση της εντολής από το ασύρματο τηλεχειριστήριο στην εσωτερική μονάδα. Μετά από άλλα 2 δευτερόλεπτα θα εξαφανιστεί η ένδειξη "H" από την οθόνη και θα επανεμφανιστεί η επιλεγμένη θερμοκρασία.

Ρύθμιση της ώρας της αυτόματης απενεργοποίησης της μονάδας.

1. Πιέστε το πλήκτρο TIMER OFF. Στην οθόνη του ασύρματου τηλεχειριστηρίου θα εμφανιστεί η ένδειξη TIMER OFF, η προηγούμενη ρύθμιση της ώρας που είχε γίνει και η ένδειξη "H". Τώρα μπορείτε να ρυθμίσετε την νέα ώρα αυτόματης απενεργοποίησης της μονάδας.
2. Πιέστε άλλη μια φορά το πλήκτρο TIMER OFF για να ορίσετε την επιθυμητή ώρα της αυτόματης απενεργοποίησης της μονάδας. Κάθε φορά που πιέζετε το συγκεκριμένο πλήκτρο η ώρα θα αυξάνεται κατά 30λεπτά έως τις 10 ώρες και έπειτα κατά 1 ώρα έως τις 24 ώρες.
3. Αφού ολοκληρώσετε τη ρύθμιση του TIMER OFF, θα υπάρξει μια χρονοκαθυστέρηση ενάμιση δευτερολέπτου για την μετάδοση της εντολής από το ασύρματο τηλεχειριστήριο στην εσωτερική μονάδα. Μετά από άλλα 2 δευτερόλεπτα θα εξαφανιστεί η ένδειξη "H" από την οθόνη και θα επανεμφανιστεί η επιλεγμένη θερμοκρασία.

▲ ΠΡΟΣΟΧΗ

- Όταν επιλέξετε την λειτουργία TIMEK, το τηλεχειριστήριο μεταδίδει αυτόματα το σήμα χρονδιακόπη στην εσωτερική μονάδα για το καθορισμένο χρόνο. Ως εκ τούτου το τηλεχειριστήριο θα πρέπει να βρίσκεται σε θέση όπου μπορεί να μεταδίδει το σήμα στην εσωτερική μονάδα σωστά.
- Οι ρυθμίσεις που μπορούν να γίνουν στο ασύρματο τηλεχειριστήριο για τη λειτουργία του χρονδιακόπη είναι οι παρακάτω: 0.5, 1.0, 1.5, 2.0, 2.5, 3.0, 3.5, 4.0, 4.5, 5.0, 5.5, 6.0, 6.5, 7.0, 7.5, 8.0, 8.5, 9.0, 9.5, 10, 11, 12, 13, 14, 15,16,17, 18, 19, 20, 21,22, 23 και 24.

Παράδειγμα της ρύθμισης του timer

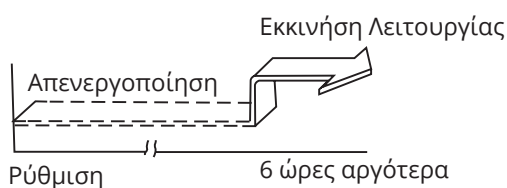
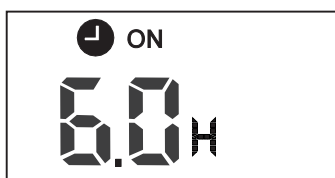

TIMER ON

(Αυτόματη ενεργοποίηση της μονάδας)

Η λειτουργία TIMER ON είναι χρήσιμη όταν θέλετε η μονάδα να ενεργοποιηθεί αυτόματα πριν επιστρέψετε σπίτι. Η κλιματιστική μονάδα θα εκκινήσει αυτόματα την λειτουργία την ώρα που έχει επιλεγεί.

Παράδειγμα:

Ενεργοποίηση της κλιματιστικής μονάδας σε 6 ώρες.

1. Πιέστε το πλήκτρο TIMER ON. Στην οθόνη του ασύρματου τηλεχειριστηρίου θα εμφανιστεί η ένδειξη TIMER ON, η προηγούμενη ρύθμιση της ώρας που είχε γίνει και η ένδειξη "H".
2. Πιέστε το πλήκτρο TIMER ON μέχρι να εμφανιστεί στην οθόνη του ασύρματου τηλεχειριστηρίου η ένδειξη "6.0H".
3. Μετά από 3 δευτερόλεπτα θα επανεμφανιστεί στην οθόνη η επιλεγμένη θερμοκρασία. Τώρα έχει πλέον ενεργοποιηθεί η λειτουργία.

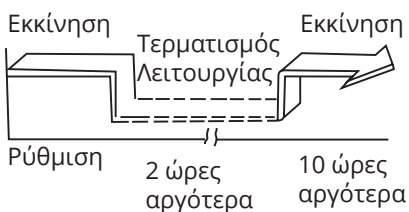
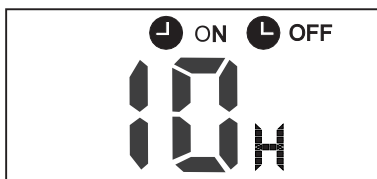
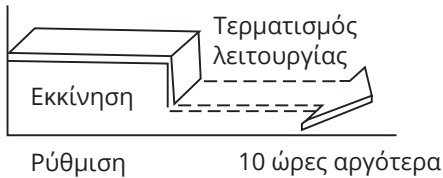
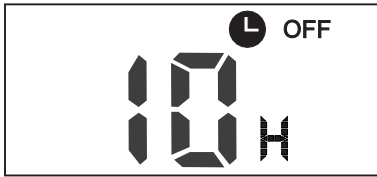

TIMER OFF

(Αυτόματη απενεργοποίηση της μονάδας)

Η λειτουργία TIMER OFF είναι χρήσιμη όταν θέλετε να απενεργοποιηθεί η μονάδα όταν πέσετε για ύπνο. Η κλιματιστική μονάδα θα απενεργοποιηθεί αυτόματα την ώρα που έχει επιλεγεί.

Παράδειγμα:

Διακοπή λειτουργίας της κλιματιστικής μονάδας μετά από 10 ώρες.

1. Πιέστε το πλήκτρο TIMER OFF. Στην οθόνη του ασύρματου τηλεχειριστηρίου θα εμφανιστεί η ένδειξη TIMER OFF, η προηγούμενη ρύθμιση της ώρας που είχε γίνει και η ένδειξη "H".
2. Πιέστε το πλήκτρο TIMER OFF μέχρι να εμφανιστεί στην οθόνη του ασύρματου τηλεχειριστηρίου η ένδειξη "10H".
3. Μετά από 3 δευτερόλεπτα θα επανεμφανιστεί στην οθόνη η επιλεγμένη θερμοκρασία. Τώρα έχει πλέον ενεργοποιηθεί η λειτουργία.

Ταυτόχρονη ρύθμιση TIMER ON και TIMER OFF

Διακοπή λειτουργίας → Εκκίνηση λειτουργίας

Αυτή η ρύθμιση είναι χρήσιμη όταν θέλετε η κλιματιστική μονάδα να διακόψει τη λειτουργία της όταν ξαπλώσετε το βράδυ και να ενεργοποιηθεί η λειτουργία της όταν ξυπνήσετε το πρωί ή όταν επιστρέψετε στο σπίτι.

Παράδειγμα:

Διακοπή λειτουργίας της κλιματιστικής μονάδας 2 ώρες μετά την ρύθμιση και εκκίνηση λειτουργίας της μονάδας 10 ώρες μετά την ρύθμιση.

1. Πιέστε το πλήκτρο TIMER OFF.
2. Πιέστε το πλήκτρο TIMER OFF μέχρι να εμφανιστεί στην οθόνη η ένδειξη 2.0H.
3. Πιέστε το πλήκτρο TIMER ON.
4. Πιέστε το πλήκτρο TIMER ON μέχρι να εμφανιστεί στην οθόνη η ένδειξη 10H.
5. Περιμένετε μέχρι να εμφανιστεί στην οθόνη η επιλεγμένη θερμοκρασία.

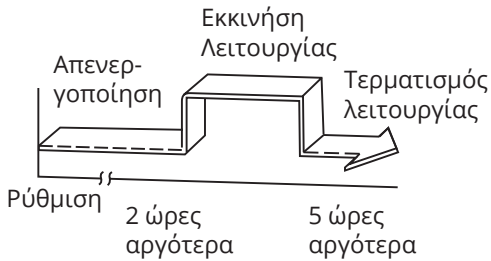
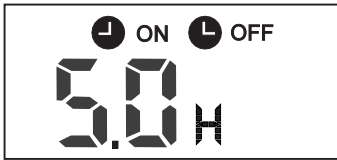

Εκκίνηση λειτουργίας → Διακοπή λειτουργίας
Αυτή η λειτουργία είναι χρήσιμη όταν θέλετε
η κλιματιστική μονάδα να ενεργοποιηθεί πριν
ξυπνήσετε και να διακόψει τη λειτουργία της όταν
φύγετε από το σπίτι.

Παράδειγμα:

Ενεργοποίηση της κλιματιστικής μονάδας 2 ώρες μετά
τη ρύθμιση και διακοπή λειτουργίας 5 ώρες μετά την
ρύθμιση.

1. Πιέστε το πλήκτρο TIMER ON.
2. Πιέστε το πλήκτρο TIMER ON μέχρι να εμφανιστεί
στην οθόνη η ένδειξη 2.0H.
3. Πιέστε το πλήκτρο TIMER OFF.
4. Πιέστε το πλήκτρο TIMER OFF μέχρι να εμφανιστεί
στην οθόνη η ένδειξη 5.0H.
5. Περιμένετε μέχρι να εμφανιστεί στην οθόνη η
επιλεγμένη θερμοκρασία.

Χειρισμός του Ασύρματου Τηλεχειριστηρίου

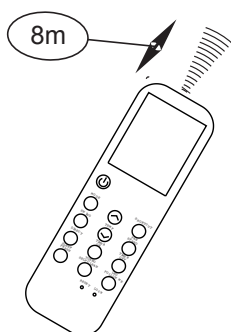
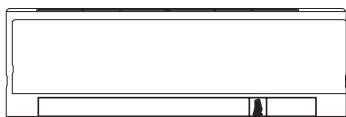

Θέση του Ασύρματου Τηλεχειριστηρίου

• Να χρησιμοποιείτε το ασύρματο τηλεχειριστήριο εντός 8μ από την κλιματιστική μονάδα στοχεύοντας στον δέκτη σήματος. Η αποδοχή της εντολής συνοδεύεται από ένα ήχο.

⚠ ΠΡΟΣΟΧΗ

- Η κλιματιστική μονάδα δεν θα λειτουργεί αν εμποδίζονται οι εντολές του ασύρματου τηλεχειριστηρίου προς την εσωτερική μονάδα από κουρτίνες, πόρτες ή άλλα αντικείμενα.
- Αποφύγετε την εισροή νερού στο ασύρματο τηλεχειριστήριο. Βεβαιωθείτε πως δεν είναι εκτεθειμένο σε ηλιακή ακτινοβολία ή σε πηγή θερμότητας.
- Εάν ο υπέρυθρος δέκτης εντολής της εσωτερικής μονάδας είναι εκτεθειμένος στην ηλιακή ακτινοβολία, η κλιματιστική μονάδα μπορεί να μην λειτουργεί σωστά. Χρησιμοποιήστε τις κουρτίνες για να αποφύγετε την απευθείας ηλιακή ακτινοβολία στον δέκτη της μονάδας.
- Εάν άλλες συσκευές επηρεάζουν τη λειτουργία του ασύρματου τηλεχειριστηρίου, απομακρύνετε αυτές τις συσκευές ή συμβουλευτείτε τον προμηθευτή σας.

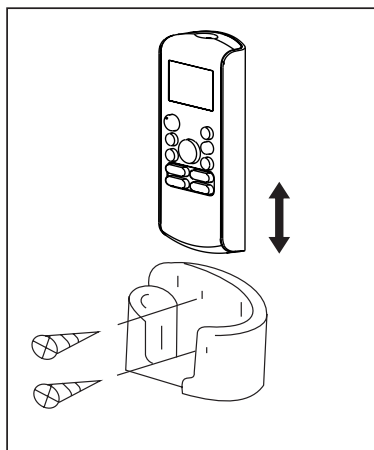

Χρησιμοποιώντας τη θήκη τηλεχειριστηρίου (προαιρετικό)

- Το τηλεχειριστήριο μπορεί να προσαρτηθεί στο τοίχο ή σε κολώνα χρησιμοποιώντας μια ειδική θήκη (δεν παρέχεται, θα πρέπει αγοραστεί ξεχωριστά).
- Πριν εγκαταστήσετε το τηλεχειριστήριο, βεβαιωθείτε ότι η κλιματιστικό λαμβάνει σωστά τα σήματα
- Τοποθετήστε την θήκη του τηλεχειριστηρίου με δύο βίδες
- Για την εγκατάσταση ή την αφαίρεση του τηλεχειριστηρίου, κίνηση προς τα πάνω ή προς τα κάτω προς στην υποδοχή.

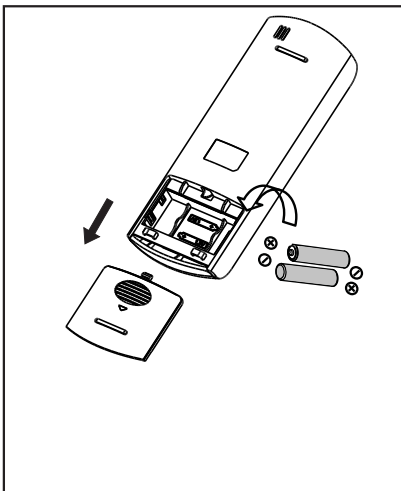

Αντικατάσταση μπαταριών

Αντικαταστήστε τις μπαταρίες όταν δεν ακούτε τον αντίστοιχο ήχο από την εσωτερική μονάδα ή όταν η ένδειξη εντολής στο ασύρματο τηλεχειριστήριο δεν ανάβει.

Το ασύρματο τηλεχειριστήριο χρειάζεται 2 ξηρού τύπου μπαταρίες (R03/LR03X2) που βρίσκονται στην πίσω πλευρά του.

- (1) Αφαιρέστε το κάλυμα.
- (2) Αφαιρέστε τις παλιές μπαταρίες και τοποθετήστε τις νέες με σωστή φορά των άκρων (+) και (-).
- (3) Επανατοποθετήστε το κάλυμα.

Σημείωση:

Όταν αφαιρείτε τις μπαταρίες, το τηλεχειριστήριο διαγράφει όλους τους προγραμματισμούς. Μετά την επανατοποθέτηση των μπαταριών, πρέπει να το ρυθμίσετε ξανά.

⚠ ΠΡΟΣΟΧΗ

- Μην τοποθετείτε τις παλιές μπαταρίες μαζί με τις νέες ή με άλλου τύπου.
- Εάν δεν πρόκειται να χρησιμοποιήσετε το ασύρματο τηλεχειριστήριο για 2 με 3 μήνες να αφαιρείτε τις μπαταρίες.
- Να απορρίπτετε τις παλιές μπαταρίες σε ειδικά δοχεία που υπάρχουν σε καταστήματα.

CUPRINS

Specificațiile telecomanzii	3
Tastele de funcționare	4
Indicațiile afisajului	7
Cum sa folosim tastele	8
Funcționarea Auto	8
Răcire / încălzire / Ventilare.....	8
Funcția de dezumidificare	9
Funcția de programare	10
Fixarea de perete a telecomanzii.....	14

NOTA:

- Design-ul tastelor se bazează pe modelul de tipic și pot fi ușor diferite față de cel real pe care l-ați achiziționat. Forma actuala va prevala.
- Toate funcțiile descrise sunt realizate de către aparat. Dacă unitatea nu are această funcție, nu va exista nici o operațiune corespunzătoare atunci când apăsați tasta de pe telecomandă.
- Atunci când există diferențe mari între Manual Telecomenzii și Manualul de Utilizare pe descrierea funcției, descrierea din MANUALUL DE UTILIZARE prevalează.

Specificațiile Telecomenzii

Model	RG57A3/BGEF, RG57A2/BGEF, RG57B/BGE, RG57D/BGE
Tensiune nominală	3.0V (Dry batteries R03/LR03X2)
Interval primire semnal	8m
Mediu ambiental	-5°C~ 60°C

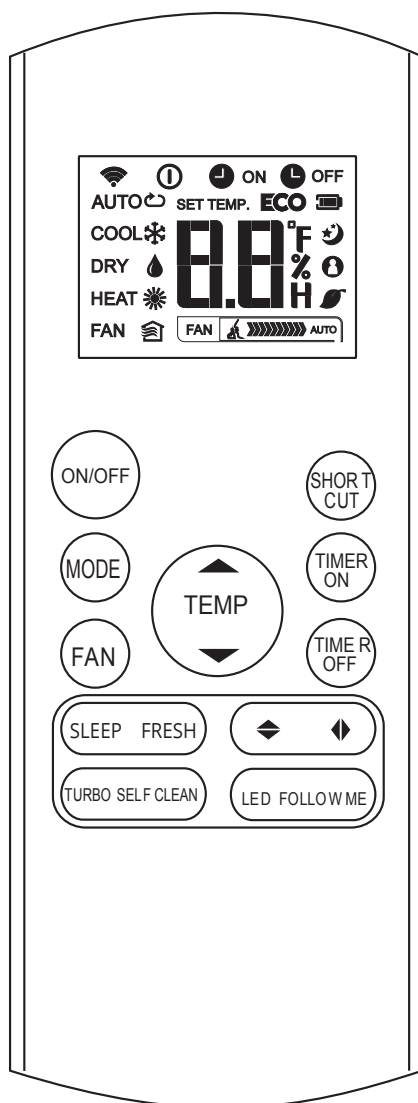

Funcțiile tastelor

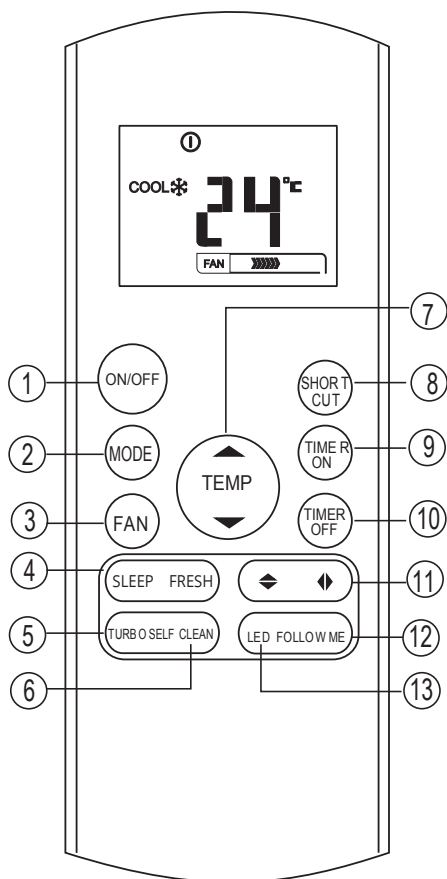

❶ Tasta PORNIT/OPRIT

Aceasta tasta pornește sau oprește aparatul de aer condiționat.

❷ Tasta MODE

Apasați această tasta pentru a modifica modul de funcționare al aparatului după cum urmează:

→ AUTO → COOL → DRY → HEAT → FAN →

NOTĂ: Vă rugăm să nu selectați modul ÎNCĂLZIRE dacă aparatul achiziționat este doar cu mod de RĂCIRE. Modul de ÎNCĂLZIRE nu este susținut de acest model de aparat.

❸ Tasta VENTILARE

Folosiți unul din următorii pași pentru a selecta viteza ventilatorului:

→ AUTO → LOW → MED → HIGH →

NOTA: Nu puteți modifica viteza ventilatorului în modul AUTO sau DEZUMIDIFICARE

❹ Tasta SLEEP

- Activează / Dezactivează funcția SLEEP. În acest mod se poate menține temperatura optimă cu o economie de energie. Această funcție este disponibilă doar pe modul AUTO, RĂCIRE sau ÎNCĂLZIRE.

- Pentru detalii, consultați "Funcția SLEEP" din Manualul Utilizatorului.

NOTĂ: În timp ce aparatul funcționează în modul SLEEP, se anulează această funcție dacă se apasă MODE, FAN SPEED sau butonul ON / OFF.

Tasta FRESH (nu e disponibil)

❺ Tasta TURBO

Activează / Dezactivează funcția Turbo. Această funcție permite unității să atingă temperatura presetată la de răcire sau de încălzire în cel mai scurt timp (în cazul în care unitatea interioară nu acceptă această funcție, nu există nici o altă operație corespunzătoare atunci când apăsați această tasta).

❻ Tasta AUTOCURATARE (nu e disponibil)

Funcțiile tastelor

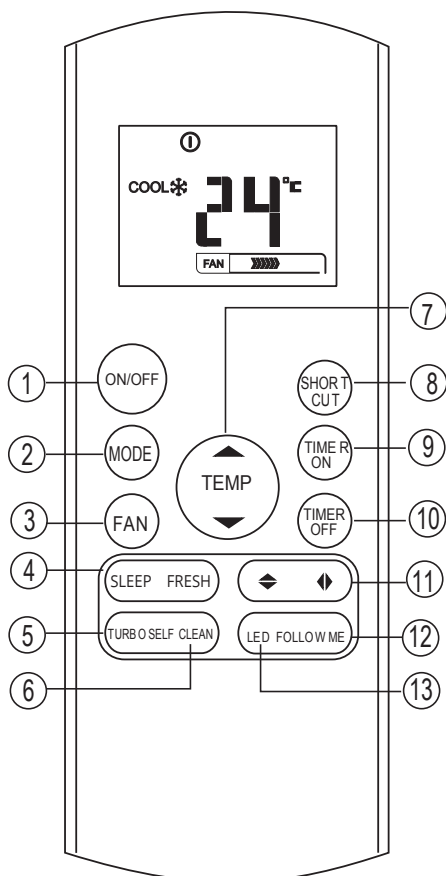

7 Tasta SUS (▲)

Apăsați aceasta tasta pentru a mări setarea temperaturii interioare în trepte cu 1 °C pana la 30°C.

Tasta SUS (▼)

Apăsați aceasta tasta pentru a scadea setarea temperaturii interioare în trepte cu 1°C pana la 17°C.

NOTA: Controlul temperaturii nu este disponibil in Modul Ventilare

8 Tasta SHORTCUT

- Se folosește pentru a reveni la setările curent sau cele anterioare

La prima conectare la priză, dacă se apasă pe tasta SCURTĂTURĂ, aparatul va funcționa în modul AUTO, 26°C și viteza ventilatorului va fi automată.

- Apăsați aceasta tastă când telecomanda este pornită, și aparatul se va întoarce automat la setările anterioare incluzând modul de funcționare, temperatura setată, viteza ventilatorului și la modul SLEEP (dacă este activat).

- Dacă apăsați mai mult de 2 secunde, aparatul va reveni în mod automat la setările curente, incluzând modul de funcționare, viteza ventilatorului și funcția SLEEP (dacă este activată).

9 Tasta PORNIRE PROGRAMARE

Apăsați acesta tasta pentru a iniția pornirea programata. Fiecare apăsare va mări setarea în trepte de 30 minute. Când timpul de setare afiseaza 10.0, fiecare apăsare va crește timpul de auto setare 60 minute in trepte. Pentru a anula pornirea programata, pur și simplu apasati pana se afiseaza la timp 0.0.

10 Tasta OPRIRE PROGRAMARE

Apăsați acesta tasta pentru a iniția oprirea programata. Fiecare apăsare va mări setarea în trepte de 30 minute. Când timpul de setare afiseaza 10.0, fiecare apăsare va crește timpul de auto setare 60 minute in trepte. Pentru a anula oprirea programata, pur și simplu apasati pana se afiseaza la timp 0.0.

Funcțiile tastelor

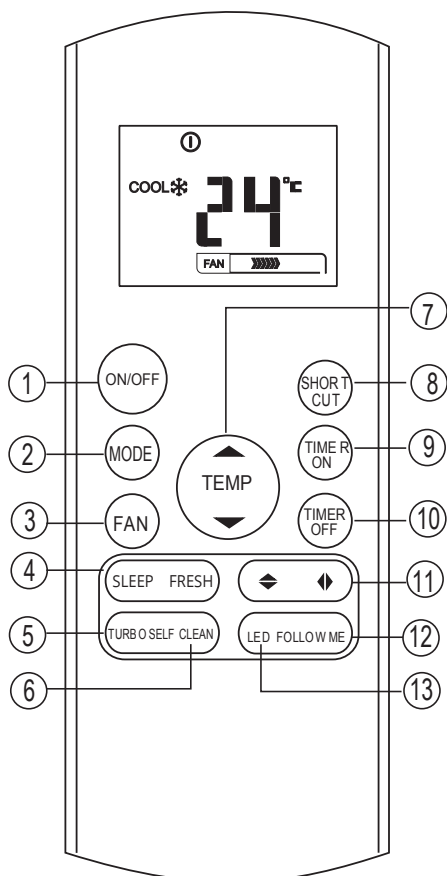

⑪ Tasta de mișcare a flapsurilor sus jos ⬆

Se utilizează pentru oprirea sau pornirea mișcării orizontale a orificiului sau pentru stabilirea direcției de curgere a aerului în sus / în jos. Chiuveta modifică 6 grade în unghi pentru fiecare presă. Dacă țineți apăsat timp de mai mult de 2 secunde, culoarea se va mișca automat în sus și în jos.

Tasta de mișcare a flapsurilor stanga dreapta ◀▶

Nu este disponibil pentru aceste serii.

⑫ Tasta FOLLOW ME

(Aceasta funcție nu este disponibilă pentru unitățile tip coloană)

Apăsați acest buton pentru a iniția funcția FollowMe, iar temperatura afișată pe telecomandă este cea reală unde este această amplasată. Telecomanda va trimite semnal la aparatul de aer condiționat la fiecare interval de 3 minute, până apăsați butonul Follow Me din nou. Instalația de aer condiționat va anula automat funcția FollowMe dacă nu primește semnal în interval de 7 minute.

⑬ Tasta AFISAJ

Activează / Dezactivează afișajul de la unitatea interioară. Când se apasă, afișajul dispare iar pentru a se aprinde iar, mai apăsați o dată.

Indicatori pe atisaj

Indicatorii sunt afișați când telecomanda este activată.

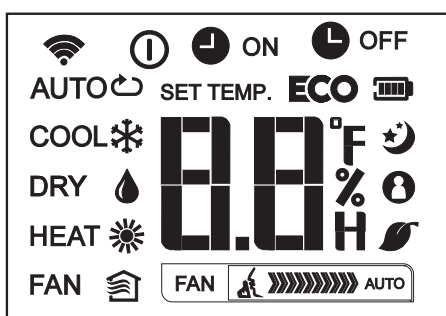

Mod afisaj

AUTO COOL DRY
HEAT FAN

- Se afiseaza când se trimite semnalul.
- Se afiseaza când telecomanda este pornita
- Afisaj baterie (detectare baterie descarnata)
- ECO** Nu este disponibil pentru acest aparat
- ON Se afiseaza când Pornirea Programata este activata.
- OFF Se afiseaza când Oprirea Programata este activata.
- Afișați temperatura setată sau temperatura camerei sau ora în setarea TIMER.

- Se afiseaza in timpul Modulii Sleep
- Indica faptul ca aparatul funcționează in Modul Follow Me.
- Nu este disponibil pentru acest aparat
- Nu este disponibil pentru acest aparat

Indicator viteza ventilator

- FAN Indicator viteza ventilator
- FAN Viteza medie
- FAN Viteza mare
- FAN Viteza Auto

Notă:

Toți indicatorii prezentați în desen sunt în scopul de a avea o prezentare clară. Dar în timpul funcționării reale numai semnele relative funcționale sunt afișate.

Cum sa folosiți tastele

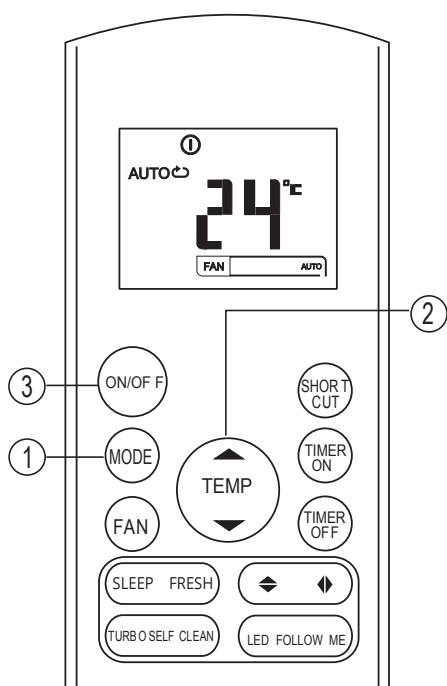

Funcționare auto

Asigurați-vă că aparatul este conectat și alimentat cu energie electrică. Indicatorul de funcționare de pe panoul de afișaj al unității interioare începe să clipească.

1. Apăsați butonul MODE pentru a selecta Auto.
2. Apăsați butonul sus / jos pentru a seta temperatura dorită. Temperatura poate fi setată într-un interval de 17°C ~ 30°C în trepte 1 °C.
3. Apăsați butonul ON / OFF pentru a porni aparatul de aer condiționat.

NOTA:

1. În modul Auto, aparatul de aer condiționat poate alege în mod logic modul de răcire, ventilare, încălzire și prin detectarea diferenței dintre temperatura actuală ambientală și temperatura setată pe telecomanda.
2. În modul Auto, nu puteți schimba viteza ventilatorului. Acesta a fost deja controlată automat.
3. Dacă modul Auto nu este confortabil pentru tine, modul de funcționare dorit poate fi selectat manual.

Răcire / încălzire / Ventilare

Asigurați-vă că aparatul este conectat și alimentat cu energie electrică.

1. Apăsați butonul MODE pentru a selecta modul RĂCIRE sau ÎNCĂLZIRE (pentru modelele cu răcire și încălzire) sau VENTILARE.
2. Apăsați butoanele sus / jos pentru a seta temperatura dorită.
3. Apăsați butonul VENTILARE pentru a selecta viteza ventilatorului în patru trepte - Auto, Mica, Medie sau Mare.
4. Apăsați butonul PORNIT / OPRIT pentru a porni aparatul de aer condiționat. Temperatura poate fi setată într-un interval de 17°C ~ 30°C în trepte de 1°C.

NOTA:

In modul de VENTILARE< temperatura setata nu este afisata pe telecomanda si nici nu o puteti ajusta. In acest caz, puteti parcurge pașii 1.3 si 4.

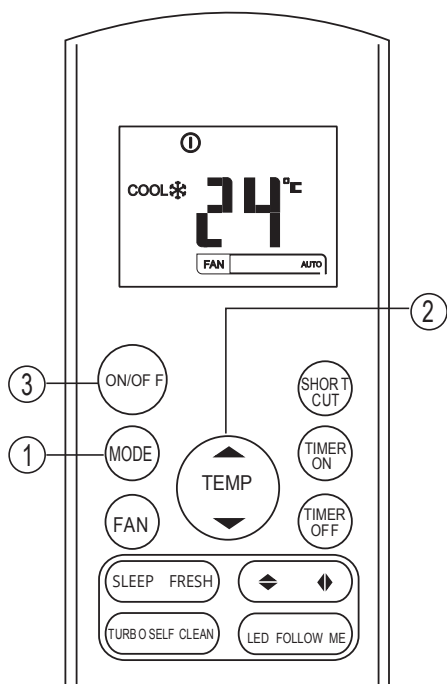

Cum sa folosiți tastele

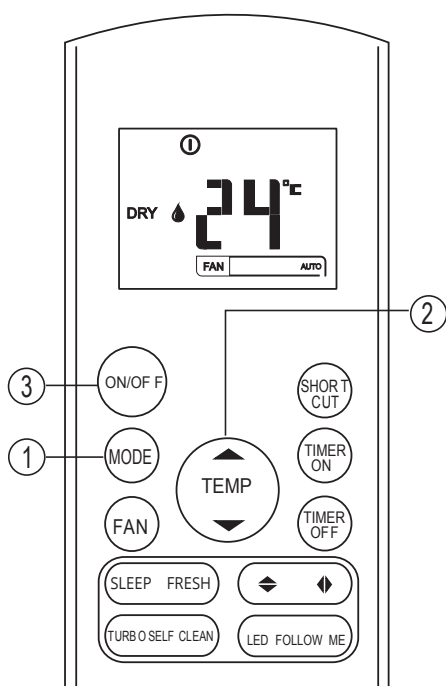

Funcționarea in Dezumidificare

Asigurați-vă că aparatul este conectat și alimentat cu energie electrică. Indicatorul de funcționare de pe panoul de afișaj al unității interioare începe să clipească.

1. Apăsăți butonul MODE pentru a selecta modul DEZUMIDIFICARE.
2. Apăsăți tastele sus / jos pentru a seta temperatura dorită.
3. Apăsăți butonul PORNIT / OPRIT pentru a porni aparatul de aer condiționat. Temperatura poate fi setată într-un interval de 1 7°C ~ 30°C în trepte de 1°C.

NOTA:

În modul de Dezumidificare, nu puteți schimba viteza ventilatorului. Acesta a fost deja controlată automat.

Ajustarea fluxului de aer

(disponibil numai pentru unitățile de Podea/Tavan)

Utilizați tasta SWING  pentru a regla direcția fluxului de aer dorită.

Direcțiile Sus / Jos pot fi ajustate cu ajutorul tastei de pe telecomanda. De fiecare dată când apăsați butonul, flapsul se mișcă cu un unghi de 6 grade. Dacă apăsați mai mult de 2 secunde, flapsul se va misca in sus și în jos în mod automat.

NOTA:

Cand flapsurile se misca intr-o pozitie care afecteaza functia de Racire sau Incalzire isi vor misca pozitia in mod automat.

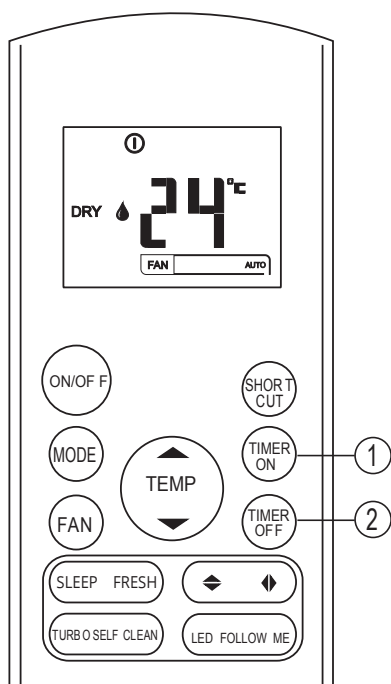

Funcția de Programare

Apăsați tasta TIMER ON și aceasta poate seta programarea auto în timp a unității. Apăsați butonul TIMER OFF și aceasta poate seta oprirea programarea a unității.

Setare pornirii programate

1. Apăsați tasta TIMER ON. Telecomanda va afișa TIMER ON, și ultima programare Auto și semnalul "H" va fi afișat pe LCD. Acum este gata pentru a reseta programarea Auto pentru a începe operațiunea.
2. Apăsați iar tasta TIMER ON pentru a seta timpul dorit. De fiecare dată când apăsați tasta, timpul crește cu o jumătate de oră între 0 și 10 ore și cu o oră între 10 și 24 de ore.
3. După setarea TIMER ON, va exista o întârziere de o secundă înainte de a se transmite semnalul de la telecomanda la aparatul de aer condiționat. Apoi, după încă aproximativ 2 secunde, semnalul "h" va dispărea, iar temperatura setată va re-apărea pe afișaj LCD.

Setare opririi programate

1. Apăsați tasta TIMER OFF. Telecomanda va afișa TIMER OFF, și ultima programare Auto și semnalul "H" va fi afișat pe LCD. Acum este gata pentru a reseta programarea Auto pentru a începe operațiunea.
2. Apăsați iar tasta TIMER OFF pentru a seta timpul dorit. De fiecare dată când apăsați tasta, timpul crește cu o jumătate de oră între 0 și 10 ore și cu o oră între 10 și 24 de ore.
3. După setarea TIMER OFF, va exista o întârziere de o secundă înainte de a se transmite semnalul de la telecomanda la aparatul de aer condiționat. Apoi, după încă aproximativ 2 secunde, semnalul "h" va dispărea, iar temperatura setată va re-apărea pe afișaj LCD.

▲ ATENTIE

- Când selectați operațiunea timer, telecomanda transmite automat semnalul de programare la unitatea interioară pentru timpul specificat. Prin urmare, plasați telecomanda într-un loc în care să poată transmite semnalul la unitatea interioară în mod corect.
- Timpul efectiv de funcționare stabilit de telecomanda pentru funcția de programare este limitat la următoarele setări: 0,5, 1,0, 1,5, 2,0, 2,5, 3,0, 3,5, 4,0, 4,5, 5,0, 5,5, 6,0, 6,5, 7,0, 7,5, 8,0, 8,5, 9,0, 9,5, 10, 11, 12, 13, 14, 15, 16, 17, 18, 19, 20, 21, 22, 23 și 24.

Exemplu de programre

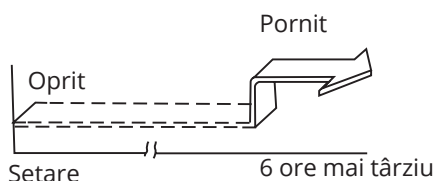
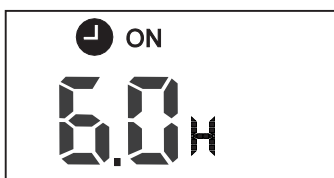

PORNIRE PROGRAMATA (Pornire Auto)

Funcția TIMER ON este utilă atunci când doriți ca aparatul să pornească automat, înainte de a reveni acasă. Aparatul de aer condiționat va porni automat la ora setată.

Exemplu:

Pentru a porni aparatul de aer condiționat în 6 ore.

1. Apăsați tasta TIMER ON, și ultima setare împreună cu semnalul "H" va apărea pe zona de afișare.
2. Apăsați tasta TIMER ON pentru a afișa "6.0H" pe cronometrul telecomenzii.
3. Așteptați timp de 3 secunde, iar zona de afișare digitală va afișa din nou temperatura. Indicatorul "TIMER ON" rămâne afișat și această funcție este activată.

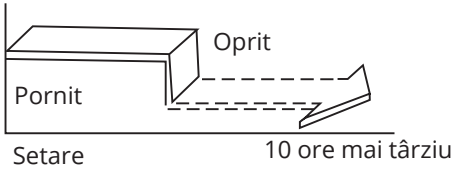
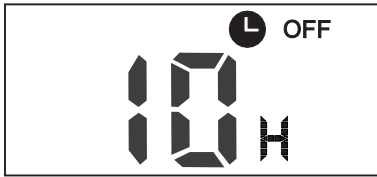

OPRIRE PROGRAMATA (Oprire Auto)

Funcția TIMER OFF este utilă atunci când doriți ca aparatul să pornească automat, după ce va culcați. Aparatul de aer condiționat se va opri automat la ora setată.

Exemplu:

- Pentru a opri aparatul de aer condiționat în 10 ore.
1. Apăsați tasta TIMER OFF, și ultima setare împreună cu semnalul 'H' va apărea pe zona de afișare.
 2. Apăsați tasta TIMER OFF pentru a afișa "10.OH" pe cronometrul telecomenzii.
 3. Așteptați timp de 3 secunde, iar zona de afișare digitală va afișa din nou temperatura. Indicatorul "TIMER OFF" rămâne afișat și această funcție este activată.

TIMP COMBINAT

(Setarea pornirii și opririi în același timp)

OPRIRE PORNIRE

PROGRAMATA → PROGRAMATA

(Pornit → Oprit → Pornire funcționare)

Această caracteristică este utilă atunci când doriți să opriți aparatul de aer condiționat după ce a mergeți la culcare, și să îl porniți din nou în dimineața când vă treziți sau atunci când vă întoarceți acasă.

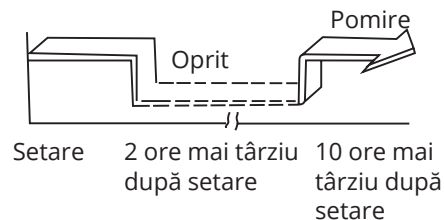
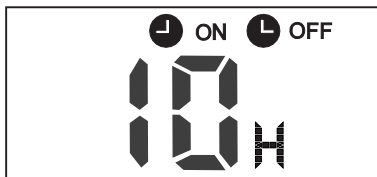

Exemplu:

Pentru a opri aparatul de aer condiționat la 2 ore după setare și pornirea din nou, 10 ore de la setare.

1. Apăsați tasta TIMER OFF.
2. Apăsați butonul TIMER OFF încă o dată pentru a afișa pe ecran 2.OH la TIMER OFF.
3. Apăsați tasta TIMER ON.
4. Apăsați TIMER ON butonul din nou pentru a afișa 10H pe cronometrul de afișare.
5. Așteptați timp de 3 secunde, iar pe zona de afișare digitală va afișa din nou temperatura. "TIMER ON OFF" indicatorul rămâne afișat și această funcție este activată.

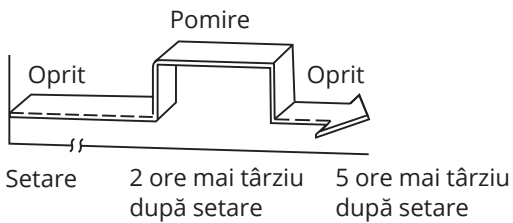
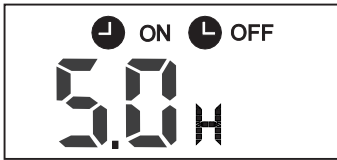

PORNIRE OPRIRE
PROGRAMATA → PROGRAMATA

(Oprit → Pornire → Oprit funcționare)

Această caracteristică este utilă atunci când doriți să porniți aparatul de aer condiționat, înainte de a vă trezi și să se oprească după ce ieșiți din casă.

Exemplu:

Pentru a porni aparatul de aer condiționat la 2 ore după setare, și să se oprească la 5 ore după setare.

1. Apăsați tasta TIMER ON.
2. Apăsați iar tasta TIMER ON pentru a afișa 2.OH pe cronometrul de afișare.
3. Apăsați tasta TIMER OFF.
4. Apăsați iar tasta TIMER OFF pentru a afișa 5.OH pe ecranul TIMER OFF.
5. Așteptați timp de 3 secunde, iar zona de afișare digitală va afișa din nou temperatura. Indicatorul "TIMER ON & TIMER OFF" rămân afișate și această funcție este activată.

Manevrarea telecomenzii

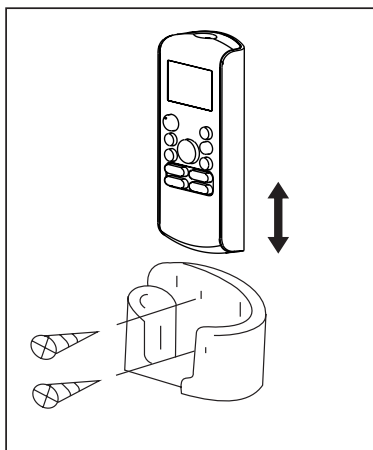
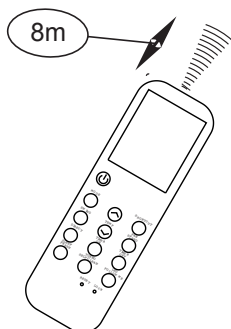
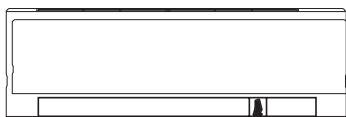

Poziționarea telecomenzii

• Folosiți telecomanda de la o distanță maximă de 8 m de aparatul de aer condiționat, îndreptând-o spre acesta. Receptarea semnalului este confirmată de un beep sonor.

⚠ ATENȚIE

- Instalația de aer condiționat nu va funcționa dacă sunt perdele, uși sau alte materiale care blochează semnalul de la telecomandă la unitatea interioară.
- Preveniți varsarea de orice lichid pe telecomandă. Nu expuneți telecomanda la lumina directă a soarelui sau la căldură.
- Dacă receptorul de semnal infraroșu de la unitatea interioară este expus la lumina directă a soarelui, există posibilitatea ca aparatul de aer condiționat să nu funcționeze corespunzător. Utilizați perdele pentru a evita lumina soarelui să cadă pe receptor.
- Dacă alte aparate electrice reacționează la telecomanda aparatului de aer condiționat, fie mutați aceste aparate sau consultați distribuitorul local.
- Nu scăpați telecomanda. Manevrați-o cu grijă.
- Nu așezați obiecte grele pe telecomandă, sau nu calcați pe ea.

Folosirea suportului de telecomanda (opțional)

- Telecomanda poate fi așezată pe un perete sau stâlp cu ajutorul unui suport de telecomanda (nu este furnizat, achiziționat separat).
- Înainte de a instala suportul telecomenzii, verificați dacă aparatul de aer condiționat primește semnalele corect.
- Montați suportul pentru telecomanda cu două șuruburi.
- Pentru instalarea sau scoaterea telecomenzii din suport, se trage în sus sau în jos în suport.

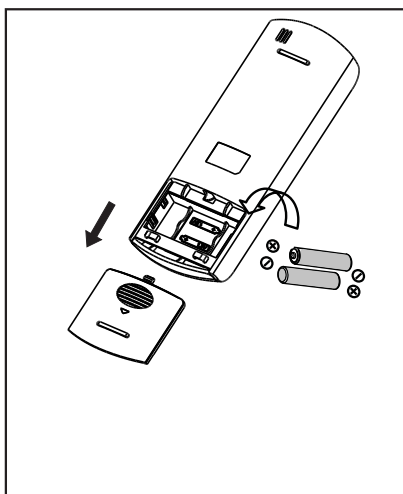

The folloînlocuirea bateriilor

Următoarele simptome indica baterii consumate, înlocuiți bateriile vechi cu unele noi.

- Nu este emis un semnal sonor atunci când un semnal este transmis către unitatea interioară.
- Afisajul de pe telecomanda dispăre.

Telecomanda este alimentată de două baterii (R03 / LR03X2) așezate în partea din spate a telecomenzii și protejate de un capac.

- (1) Scoateți capacul din partea din spate a telecomenzii.
- (2) Scoateți bateriile vechi și introduceți noile baterii, plasarea (+) și (-) se va face în mod corect.
- (3) Instalați capacul din spate pe telecomanda.

NOTĂ: *Atunci când bateriile sunt scoase, telecomanda își pierde toate setările. După introducerea bateriilor noi, telecomanda trebuie reprogramată.*

⚠ ATENȚIE

- Nu amestecați baterii sau acumulatori de diferite tipuri sau vechi cu noi.
- Nu lăsați bateriile în telecomandă, dacă acestea nu vor fi utilizate pentru 2 sau 3 luni. Nu aruncați bateriile la gunoiul municipal nesortat.
- Colectarea acestor deșeuri se face doar separat pentru un tratament special.



AIR CONDITIONING SYSTEMS

REMOTE CONTROLLER



Scan here to download the latest version of this manual.
Σαρώστε εδώ για να κατεβάσετε την τελευταία έκδοση του εγχειρίδιου.

Please check the applicable models,
F-GAS and manufacturer information from the “Owner’s Manual - Product Fiche” in the packaging of the outdoor
unit. (European Union products only).

